

Invitation To Seminar Fri., July 5, 2024 • 5-10:30 PM

Le Royal Meridien • Chennai, Tamil Nadu 600016, India

Presented by:

Dr. Krishnan Suthanthiran, President/Founder of
TeamBest Global Companies and Best Cure Foundation



Sponsored by Best Cure Foundation and TeamBest Global Companies

5-5:45 PM Registration—Appetizers and juice/soft drinks/coffee/tea

6-7:30 PM FIRST SESSION:

(Part 1) How can we save as many as 50% of those dying today?

(Part 2) 75 Year History of Radiation Therapy for Benign and Malignant Diseases

7:30-8 PM Break—Appetizers and Drinks

(one alcoholic beverage per person)

8-9 PM SECOND SESSION:

The Future of Cyclotrons, Theranostics and Ultrasound Imaging for Diagnosis and Treatment

Announcement of new medical centers and societies

- Opening of a New Cancer Center in Coimbatore, Tamil Nadu India with the world's first Gamma Beam 100-80 CM, Equinox Unit with built in Electronic MLC for IMRT, SBRS and Active RX, Treatment Planning Systems invented and manufactured by Best Theranostics, LTD. and Best Nomos companies of TeamBest Global.
- Opening of the world's first Best Cure Foundation Non-Profit Best Cure Proactive, Preventive, Primary, Medical, Dental and Eye Care Wellness Center in Coimbatore by the end of 2024.



9-10:30 PM Dinner

Assortment of vegetarian and non-vegetarian with two meat options
(one alcoholic beverage per person)

To RSVP or for more information please contact:

Vidyun Soni at +91-9911773322 (vidyun@teambest.com), Anil Shukla at +91-9560506364 (anil.shukla@teambest.com)
or Yamunashri Kumar Saravanan at +91-909599224 (yamunasarav@teambest.com)

For more information visit www.TeamBest.com or www.BestCure.md



Krishnan Suthanthiran

krish@teambest.com

*Founder and President of
TeamBest Global Companies,
Best Cure Foundation and
Kitsault Energy*



Main goals of Best Cure Foundation



1

Provide purified drinking water and affordable sewer systems in every part of the world by 2040.



2

Establish a global standard of healthcare delivery system using a hub and spoke model with express and mobile clinics linked to general and super specialty medical centers.



3

Reduce suffering/deaths from major diseases such as cardiac, cancer, diabetes, etc. by 50% by the end of the next decade.



4

Engaging in Global Food Production Growth, Conservation and Reducing Waste.



5

Encouraging young athletes, including physically challenged, to excel.



Best Cure Global Healthcare System is comprised of:

- Best Cure Health System (non-profit)
- Best Cure Insurance (non-profit)
- Best Cure Clinical Research Institute (non-profit)
- Best Medical Real Estate Investment Trust (for profit public company)
- Best Medical Capital (for profit public company)
- TeamBest Global (TBG) companies (for profit public company)



All of the non-profit organizations will be under Best Cure Foundation (BCF), a non-profit, global, private, non-governmental organization founded in 2007 and supported entirely by Krishnan Sulhanthiran, President/Founder of TBG and BCF.

Best Medical International, Inc. 7643 Fullerton Road, Springfield, VA 22153 USA
tel: 703 451 2378 800 336 4970 www.besttotalsolutions.com www.teambest.com



Best Cure Global Healthcare Delivery System

15 TRILLION U.S. DOLLAR ANNUAL GLOBAL ECONOMY



TBG companies in collaboration with the BCF plan to establish 100s of **Best Cure Global Healthcare Delivery of Proactive, Preventive, Primary Care and Multi-specialty Medical Centers** to serve the needs of the global cancer population. They aim to promote Total Health™ (prevention, early detection, effective treatment and total cure) and practice Proactive Healthcare™ (full transparency on benefits, clinical outcome and costs) and reduce the cost of healthcare by 30 percent or more.



3E: Education, Empowerment and Equality

A division under Best Cure Foundation to promote the development and advancement of women

Krishnan Suthanthiran established a division under BCF called **3E: Education, Empowerment and Equality** to promote the development and advancement of women. It is his belief that every man and woman was given birth to, nursed, and nourished by women, and therefore, they share a greater responsibility in juggling career and family, in raising children and caring for the home. In memory of his mother, Krishnan is proud to support women around the world in pursuing their goals through the 3E organization.

Having lost his father to cancer in 1968, Krishnan Suthanthiran launched his **Global War on Cancer** on April 29, 2015 in memory of him.



Best[™] **nomos**[®]

1 Best Drive Pittsburgh, PA 15202 USA
Tel: 412 312 6700 800 70 NOMOS
Fax: 412 312 6701 www.nomos.com

Best[™] **medical international**

7643 Fullerton Road Springfield, VA 22153 USA
Tel: 703 451 2378 800 336 4970
Fax: 703 451 5228 www.teambest.com

MSF-0019(R1)

Best™ Compact SimulView™ Ultrasound Imaging System

- Patented probe design with simultaneous imaging of sagittal and transverse planes
- Longitudinal array provides for 140 mm length of view encompassing the bladder, prostate and perineum
- Superior HD Image resolution for improved implant accuracy, speed and physician confidence level
- Advanced drawing and editing tools which include user-defined line widths and colors for fiducial and anatomical markers
- Advanced modular software design provides for future upgrade path via in-house and independently developed technologies
- System converts from stand-based to desktop without losing any functionality
- Supports more than 20 probes of various geometries and use locations
- **For more information please visit:**
<http://www.teambest.com/videos/Best-nomos-Compact-Sonalis-1080p.mp4>



Best[™] nomos[®] Compact Sonalis[®] Ultrasound System



- Capable of supporting over 20 different probe configurations, this system can be used in almost every discipline
- 21.5" touch screen technology
- Superior HD image resolution for improved procedure accuracy, speed and physician confidence level



Best Medical International, Inc. • 7643 Fullerton Road • Springfield, VA 22153 USA
tel 703 451 2378 800 336 4970 • www.teambest.com • www.nomos.com

Best[™] nomos[®] Compact Sonalis[®] Ultrasound System

FEATURING

SimulView[™] Ultrasound Technology

The Best[™] Sonalis[®] Ultrasound Imaging System provides superior visualization of HDR, LDR, RF or Cryosurgical procedures. Our patented SimulView[™] Technology provides simultaneous “live” views of the prostate in both planes, thereby increasing treatment accuracy and precision.

Additional Features:



- Patented probe design
- Sagittal array provides for 140 mm length of view encompassing the bladder, prostate and perineal tissue
- Advanced modular software design provides for future upgrade path
- Convertible to desktop or portable without losing any functionality
- Advanced drawing and editing tools which include user-defined line widths and colors
- Dual battery backup built-in to protect from power loss
- Multiple brachytherapy grid options with user-definable grid symbols and colors
- 21.5" touch screen with multi-point touch capabilities



Best Nomos, 1 Best Drive, Pittsburgh, PA 15202 USA
tel: 412 312 6700 800 70 NOMOS fax: 412 312 6701 www.nomos.com

A BREAKTHROUGH in ultrasound technology

Advanced keyboard technology, totally sealed and self-healing antibacterial keyboard with SensoFoil™ Technology

21.5" touch screen with multi-point touch capabilities

Multiple options for Probe Holder positions and gel bottle cups

Electric lift column for a wide range of height options

Rotating support column for easy positioning

Independent rotating/locking casters

Easily accessible ECG and computer I/O ports

Center mounted probe for maximum efficiency

Large rear handles for easy moving

Rear cable management hooks

Power cord input port easily accessible



Sonolis® Transducers

We offer probes for the most common types of procedures and imaging, all with the enhanced image quality and high resolution that you would expect from the **BEST** name in ultrasounds!

8L2A Linear Array

Applications: Arterial, Carotid, Vascular Access, Venous



12L5A Linear Array

Applications: Arterial, Breast, Carotid, Dialysis Access, Lung, Neonatal Hip, Nerve Block, Ophthalmic, Testes, Thyroid, Vascular Access, Venous



14L3 Linear Array

Applications: Arterial, Breast, Carotid, Dialysis Access, Lung, MSK, Neonatal Hip, Nerve Block, Ophthalmic, Testes, Thyroid, Vascular Access, Venous



15LW4 Linear Array

Applications: Arterial, Breast, Carotid, Dialysis Access, Lung, MSK, Neonatal Hip, Nerve Block, Ophthalmic, Testes, Thyroid, Vascular Access, Venous

Biopsy Kit Available



15LA Linear Array

Applications: Arterial, Breast, Carotid, Dialysis Access, Lung, MSK, Neonatal Hip, Nerve Block, Ophthalmic, Testes, Thyroid, Vascular Access, Venous

Biopsy Kit Available



15L4A Linear Array

Applications: Arterial, Breast, Carotid, Dialysis Access, Lung, MSK, Neonatal Hip, Nerve Block, Ophthalmic, Thyroid, Vascular Access, Venous



16L5 Linear Array

Applications: Breast, Lung, MSK, Nerve Block, Vascular Access



VET Biopsy Kit Available

8V3 Phased Array

Applications: Cardiac



4V2A Phased Array

Applications: Cardiac, FAST, TCD



5C2A Curved Array

Applications: Abdominal, FAST, Fetal Cardiac, MSK, OB/GYN, Renal, Thyroid, Visceral

Biopsy Kit Available



9MC3 Curved Array

Applications: Abdominal, Cardiac, Neonatal Head, Small Parts, Thyroid, Vascular Access



8EC4A Endocavity

Applications: OB/GYN, Prostate

Biopsy Kit Available



XY-BI-Plane Phased Array

Applications: Cardiac, Vascular, Lung



10EC4A Endocavity

Applications: OB/GYN, Prostate

Biopsy Kit Available



10BP4 Bi-Plane

Applications: Prostate



8BP4 Bi-Plane

Applications: Prostate



8TE3 Trans-esophageal

Applications: Motorized Adult Multiplane TEE Probe



Pedoff

Applications: Cardiac



16HL7 High Frequency Linear Array

Applications: MSK, Venous



Best Nomos, 1 Best Drive, Pittsburgh, PA 15202 USA
tel: 412 312 6700 800 70 NOMOS fax: 412 312 6701 www.nomos.com

TeamBest Global Companies

Best medical international

TeamBest ASIA

Best Cyclotron Systems

Best Particle Therapy

Best Theratronics

Best medical canada

Best medical italy

Best ABT Molecular Imaging

Best vascular



Best Cure
FOUNDATION



HUESTISMEDICAL
making it affordable™

Best nomos

Best Dosimetry Services

CNMC+ *Best* NDT
A TeamBest Company

 **KITSALT**
ENERGY
FUELING THE GREEN FUTURE



Best Automation & Robotics



Best Cure Foundation



www.bestcure.md



3E—Education, Empowerment and Equality



www.bestcure.md



Proud Indian Party



www.proudindian.org



International Society for Surgery & Surgical Oncology



www.issso.org



International Society for Breast Surgeons



www.isbs.ca



International Society for Radiation Medicine & Molecular Imaging



www.isrmmi.org



International Society for Radiology and Imaging



www.isri.ca



International Society for Therapeutic Radiology & Oncology



www.istro.net



International Society for Ultrasound Imaging



www.isusi.org



Kitsault Energy



www.kitsaultenergy.com



*Best*TM *medical international*

A TEAMBEST GLOBAL COMPANY

www.bestmedical.com



*Best*TM *Cyclotron Systems*

A TEAMBEST GLOBAL COMPANY

www.bestcyclotron.com



*Best*TM *Particle Therapy*

A TEAMBEST GLOBAL COMPANY

www.bestcyclotron.com/particletherapy



*Best*TM *Theratronics*

A TEAMBEST GLOBAL COMPANY

www.theratronics.ca



*Best*TM *medical canada*

A TEAMBEST GLOBAL COMPANY

www.bestmedicalcanada.com



*Best*TM *medical italy*

A TEAMBEST GLOBAL COMPANY

www.teambest.com



*Best*TM **ABT Molecular Imaging**

A TEAMBEST GLOBAL COMPANY

www.bestabt.com



*Best*TM *vascular*

A TEAMBEST GLOBAL COMPANY

www.bestvascular.com





A TEAMBEST GLOBAL COMPANY

www.bestvascular.com



*Best*TM *Automation & Robotics*

A TEAMBEST GLOBAL COMPANY

www.teambestautomation.com



*Best*TM *Dosimetry Services*

A TEAMBEST GLOBAL COMPANY

www.bestdosimetry.com



BestTM nomos[®]

A TEAMBEST GLOBAL COMPANY

www.nomos.com



TeamBest™ ASIA

A TEAMBEST GLOBAL COMPANY

www.teambest.in



Best™ NDT

A TEAMBEST GLOBAL COMPANY

www.bestndt.net





A TEAMBEST GLOBAL COMPANY

www.cnmcco.com



HUESTIS MEDICAL

making it affordable™

A TEAMBEST GLOBAL COMPANY

www.nomos.com





arplay medical

A TEAMBEST GLOBAL COMPANY

www.arplay.com





ENTERTAINMENTTM
for everyone

www.bestentertainment.ca



Radiation Therapy

75 Year History

Past, Present, and Future



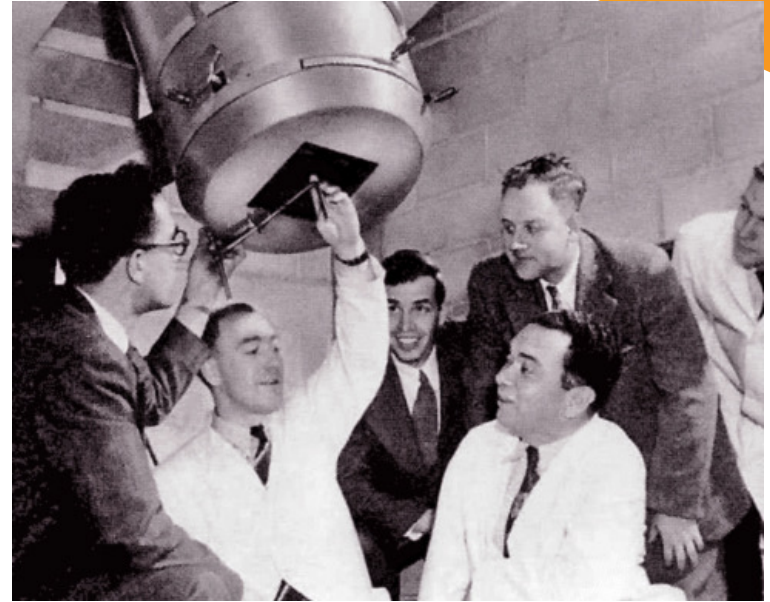

**The Eldorado A at Victoria Hospital
in London, Ontario in 1951.**

Evolution of Radiation Therapy – Cobalt-60

Cobalt 60 widely used for conventional RT in most of the world.

But..

Has lacked the required technical R&D to facilitate IMRT/IGRT...

UNTIL NOW





Best GammaBeam™ 300-100 CM Equinox™ Teletherapy System with Avanza 6D Patient Positioning Table

The **GammaBeam™ 300-100 CM Equinox™** is an evolution of the Theratron line of treatment devices. The advanced design provides freedom in treatment planning and can interface to all of the major record/verify systems to allow for rapid treatment parameter loading, treatment set-up verification and the recording of delivery.



Best™ Theratronics

A TEAMBEST GLOBAL COMPANY



Best™ GammaBeam™ 300-100 CM Equinox™ Teletherapy System with Avanza 6D Patient Positioning Table

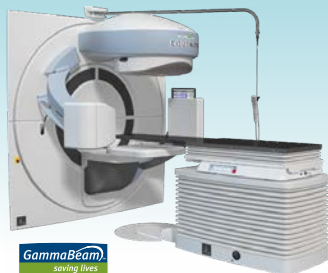

GammaBeam
Saving lives

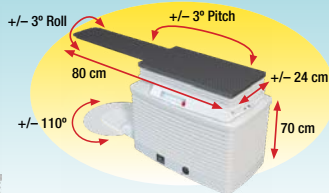

NEW! Multi-Leaf Collimator (built in or external) for 80 and 100 cm SAD units—IMRT, IGRT, SRS, SBRT and Tomotherapy capable w/ActiveRx

UPGRADE Kit

For all old Theratron units, 80 or 100 cm including IMRT capabilities w/built in or external MLC



UPGRADE includes:

- Removing all old controls, electronics and installing a new control system and covers
- Replacing the old collimator system with the new Equinox collimator
- Replacing the old treatment table with the new Avanza™ Table
- Retaining the head rotation capability is optional

UPGRADE features:

- Calculated Arc Speed
- Graphical Control System
- Asymmetric Jaws
- R&V System Ready
- Service Log Files
- On-Board Verification
- Motorized Wedge
- Collision Detection

Best Theratronics Ltd., 413 March Road, Ottawa, Ontario K2K 0E4 Canada
tel: 613 591 2100 866 792 8598 www.theratronics.com www.teambest.com

*Certain products shown are not available for sale currently.



Best[™] *medical international*

A TEAMBEST GLOBAL COMPANY

Flash
Therapy
in 1975



Flash
Therapy
Now

Robotic Flash
Therapy Linac
System



X-Beam[™]
Robotic
Radiosurgery
System

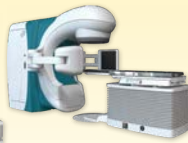

X-Beam[™] Image-Guided
Multi-Energy Linac
System

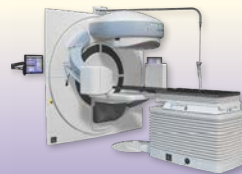

Best[™] GammaBeam[™]
300-100 CM Equinox[™]
Teletherapy System
with Avanza 6D Patient
Positioning Table

**BE PART
OF OUR TEAM**

TBG is currently hiring talented engineers manufacturing/computer/software programmers, magnet physicists, scientists, and others. Please email **Krish Suthanthiran** at Krish@teambest.com or **Jignasha Patel** at Jignasha@teambest.com.

TBG Expansion Plans

TeamBest Global Companies (TBG), in partnership with Best Cure Foundation, plan to manufacture and establish 1000s of medical centers around the globe. These centers will include Best Cure Proactive, Preventive, Primary, Medical, Dental and Eye Care Wellness Centers, as well as treatment centers for cardiac, cancer, diabetes, and infectious diseases.

TBG Companies are expanding operations in the United States and India to meet the increasing demand for manufacturing advanced medical equipment such as cyclotrons, Linacs, MRI, CT, PET CT, X-ray, Ultrasound, and other technologies. The goal is to sell and provide these technologies globally as part of the Best Cure Global Healthcare Delivery.



Best Medical International, Inc. | 7643 Fullerton Road | Springfield, VA 22153 USA
tel: 703 451 2378 800 336 4970 www.besttotalsolutions.com www.teambest.com

AFRICA | ASIA | EUROPE | LATIN AMERICA | MIDDLE EAST | NORTH AMERICA

*Certain products shown are not available for sale currently. TeamBest Global Companies ©2024



Best™ Cyclotron Systems

A TEAMBEST GLOBAL COMPANY

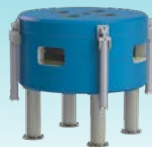

Best Model B25p
Cyclotron



Best Model 6-15 MeV
Compact High Current/
Variable Energy Proton
Cyclotron



Best B 100p, BG 95p and B 11p
Sub-Compact Self-Shielded Cyclotron
w/Optional Second Chemistry Module



Best Model B35ADP
Alpha/Deuteron/Proton
Cyclotron



Installation of B70 MeV Cyclotron at INFN, Legnaro, Italy.



Best Particle Therapy 400 MeV ion Rapid
Cycling Medical Synchrotron (IRCMS)

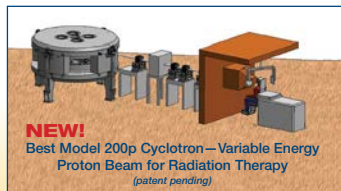

NEW!
Best Model 200p Cyclotron—Variable Energy
Proton Beam for Radiation Therapy
(patent pending)

Best Cyclotron Systems, Inc. | 3024 Topside Business Park Drive | Louisville, Tennessee 37777 USA
tel: 613 591 2100 866 792 8598 www.theratronics.com www.teambest.com

AFRICA | ASIA | EUROPE | LATIN AMERICA | MIDDLE EAST | NORTH AMERICA

*Certain products shown are not available for sale currently. TeamBest Global Companies ©2024



INTRACAVITARY AND INTERSTITIAL RADIATION THERAPY IN THE MANAGEMENT OF NASOPHARYNGEAL CANCERS

Ulrich K. Henschke MD, PhD 420 East 66th Street New York, N.Y. 10021

Invited paper and exhibit presented at the XII International Congress of Radiology in Tokyo, Japan, October 6-11, 1969. Based on clinical and experimental work carried out in cooperation with Basil S. Hilaris MD, John S. Lewis MD, David G. Mahan BA, and Felix W. Mick and supported in part by PHS grant CS 9369.

INTRACAVITARY APPLICATIONS

We have used intracavitary applications routinely in combination with external supervoltage radiation-therapy for the primary treatment of all nasopharyngeal cancers.

As in the treatment of cancer of the uterine cervix, this combination of intracavitary and external radiation results in a better dose distribution and permits a higher tumor dose. And only with the help of an intracavitary applicator is it possible to deliver to the cancerbearing portions of the nasopharynx a higher dose than to the normal portions.

Intracavitary applications have been greatly facilitated by the remote afterloader, which we first described in 1964. It has three small cobalt-60 sources, each one millimeter in diameter and 500 to 1000 millicuries. During the treatment, the patient remains in a well shielded room, and the sources are inserted by remote control from a separate control room into the previously positioned nasopharynx applicator.

For the patient, the remote afterloader provides greater comfort due to the short treatment times of 10 to 20 minutes. For the physicians and the technicians, it completely eliminates radiation exposure.

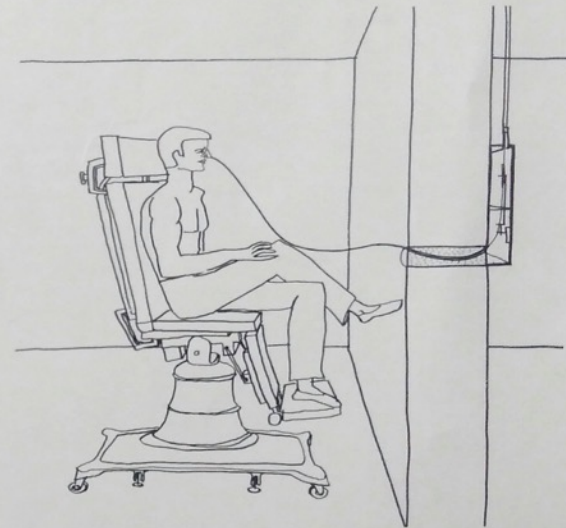

Fig. 1. Remote afterloading of intracavitary nasopharynx applicator.

Best™ HDR Afterloader



Best™ Kobold Applicators

Best™ Kobold Tandem & Ring Applicator

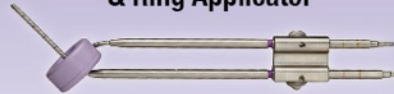

Best™ Kobold Fletcher Tandem & Ovoid Applicator



Best™ Kobold Henschke Tandem & Ovoid Applicator



Krishnan Suthanthiran's Parents





Krishnan Suthanthiran's Father

Having lost his father to cancer in 1968, Krishnan Suthanthiran launched his Global War on Cancer on April 29, 2015 in memory of him.

Global War on Cancer

Launched by Best Cure Foundation & TeamBest Companies

While there have been many significant improvements and advancements in medical technologies, many patients around the world do not receive timely interventions or the right care. Mr. Suthanthiran firmly believes more should be done. In 2007, he formed the Best Cure Foundation to work with TeamBest companies, and other leading-edge companies and experts, to establish a Hub-and-Spoke model of healthcare delivery systems to overcome these shortcomings. Best Cure Foundation's goal is to launch a **“Global War on Cancer”** that includes express and mobile clinics linked to general and super-specialty medical centers worldwide.



Global War on Cancer

Launched by Best Cure Foundation & TeamBest Companies

Mr. Suthanthiran has interacted with those in the private sector and government agencies, in more than 20 countries over the last few years in Asia, South America, the Middle East, and North America. In that time, he has stated, “It is clear that there is a groundswell of support for a better, affordable, and accessible healthcare delivery system globally.”

He has established and acquired a number of medical companies globally, in order to collect many of the technologies needed to establish a Proactive Healthcare Delivery System, focused on transparency of clinical benefits, outcome, and cost using a Total Health Approach – Prevention, Early Detection, and Effective Treatment for Total Cure.





Krishnan Suthanthiran's Mother

Krishnan Suthanthiran has established a division under BCF called “**3E – Education, Empowerment and Equality**” to promote the development and advancement of women. It is his belief that every man and woman was given birth to, nursed, and nourished by women, and therefore, they share a greater responsibility in juggling career and family, in raising children and caring for the home. In memory of his mother, Krish is proud to support women around the world in pursuing their goals through the 3E organization.



Best Cure Foundation's aim is to establish:

- Express/mobile clinics and medical centers as non-profit, private, non-governmental organizations that are self sustaining
- Best Cure U.S. Health Corps
- Best Cure International Health Corps
- Best Cure Global Institute
- Best Cure Global Standard of Care
- Best Cure Global Purchasing Organization
- Best Cure Global Insurance



As part of its **Global Healthcare Delivery System**, the Best Cure Foundation (BCF) plans to establish many 1000s of Proactive, Preventive, Primary Medical, Dental and Eye Care Wellness Centers globally.



BCF plans to establish a Cancer Center with GammaBeam 100-80 CM with built in MLC to provide IMRT, 3D-CRT, SBRT, etc., offering 24/7 with HDR, Cobalt-60/Iridium 192 Remote After Loader.



The goals of the BCF are to:

1. Provide purified drinking water and affordable sewer systems in every part of the world by 2040,
2. Establish a global standard of healthcare delivery system using a hub & spoke model with express and mobile clinics linked to general and super specialty medical centers, and
3. Reduce suffering/deaths from major diseases such as cardiac, cancer, diabetes, etc. by fifty percent toward the end of the next decade.



*Best*TM *medical international*

A T E A M B E S T G L O B A L C O M P A N Y



Best™ Seeds for Brachytherapy

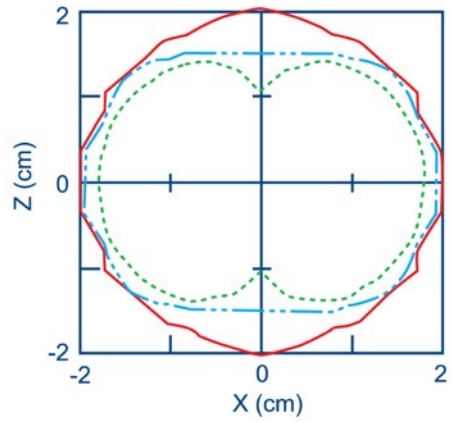

Experimentally Measured Isodose Curves of 20 cGy/h from I-125 Seeds, Best® Model 2300 Series (solid red line), Model 6702 (broken blue line) and Model 6711 (dotted green line)

Ravinder Nath and Anthony Melillo
 Medical Physics, 20(5), 1480 (1993)

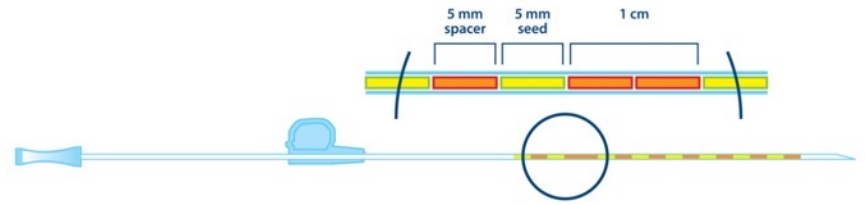

Best™ Iodine-125 Seed



Best™ Palladium-103 Seed



Best™ Iridium-192 Seeds in Nylon Ribbon















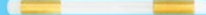
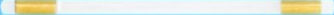

- Seeds are 3.0 mm in length and 0.5 mm in diameter
- 0.37 MeV (average) Gamma Emission Energy
- Half-life of 74.3 days
- HVL (50% attenuation) about 3 mm Lead
- Specific Gamma ray constant 4.6 R cm²/mCi/hr
- Custom spacing available

Best™ Gold-198 Seeds

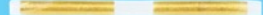
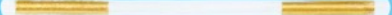

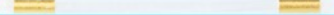
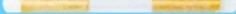
- Seeds are 2.5 mm in length and 0.8 mm in diameter
- 420 keV (average) Gamma Emission Energy
- Metallic Gold pellet encapsulated in Platinum
- Half-life of 2.7 days
- HVL (50% attenuation) about 4 mm Lead
- Specific Gamma ray constant 2.35 R cm²/mCi/hr
- Custom activities available

Best™ Radiopaque Gold Marker Strands

1 cm spaced (center to center)	2 cm spaced (center to center)
.8 mm x 3 mm 	.8 mm x 3 mm 
.8 mm x 5 mm 	.8 mm x 5 mm 
.8 mm x 7 mm 	.8 mm x 7 mm 
1 mm x 3 mm 	1 mm x 3 mm 
1 mm x 5 mm 	1 mm x 5 mm 
1 mm x 7 mm 	1 mm x 7 mm 
1.2 mm x 3 mm 	1.2 mm x 3 mm 
1.2 mm x 5 mm 	1.2 mm x 5 mm 
Stranded single markers	Custom strands and loose markers are also available!
.8 mm x 5 mm 	<i>All strands pictured have been enlarged from actual size for ease of viewing.</i>
1 mm x 5 mm 	



Best™ Localization Needles

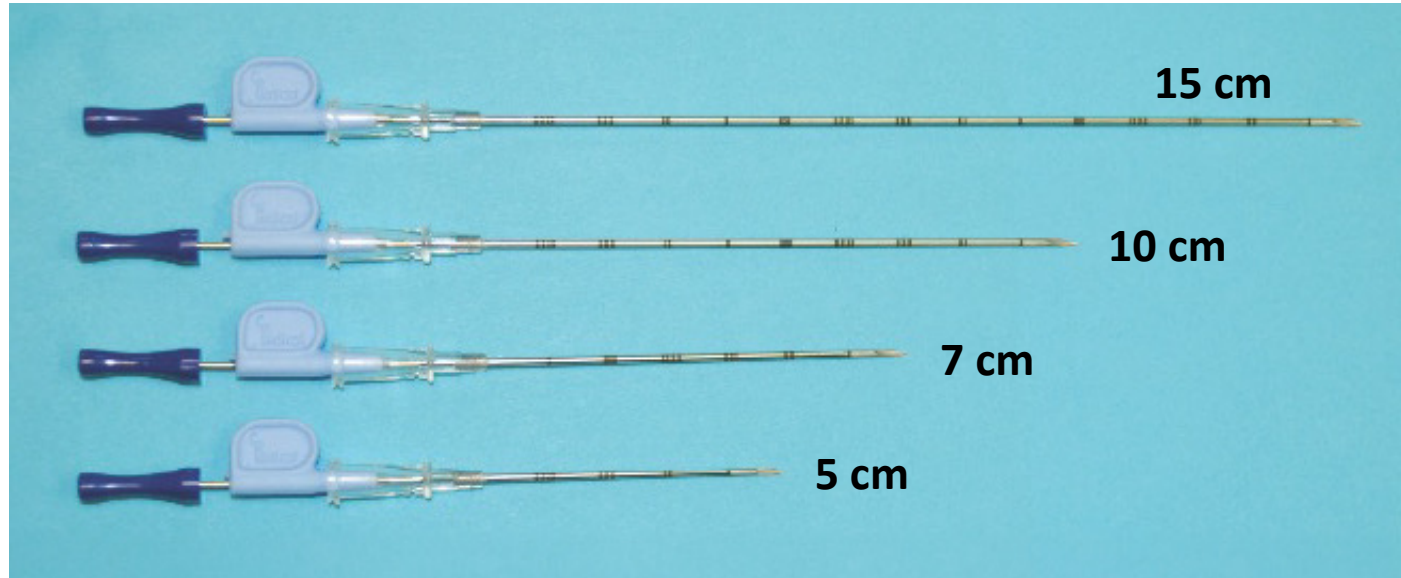

Best™ Brachytherapy Kit for Interstitial Applications



5 Implant Needles

5 Stylets with Hubs

5 Single Leader Catheters*



5 Friction Cuffs



5 Half Moon Buttons**



5 Red Caps

* Catheter tubes are available in 5 colors (purple, green, yellow, clear or blue) with either radiopaque or clear nylon buttons.

** Half Moon Buttons are available in radiopaque (pictured) or clear nylon.

Best™ Double-Balloon Breast Brachytherapy Applicator



Best™ Esophageal Brachytherapy Applicator

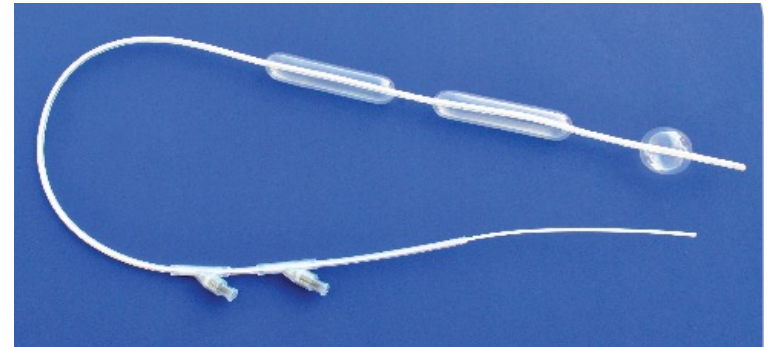

Intravascular Brachytherapy

Novoste™
Beta-Cath™
3.5F System



Best™ Templates



Central Rod (Reusable)

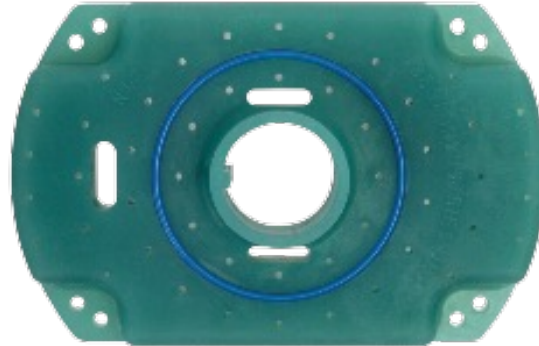

LDR GYN Template (Disposable)



GYN Template (Reusable)

BestTM nomos[®]

A TEAMBEST GLOBAL COMPANY

www.nomos.com



The Market Revolution Timeline

(1992 to)

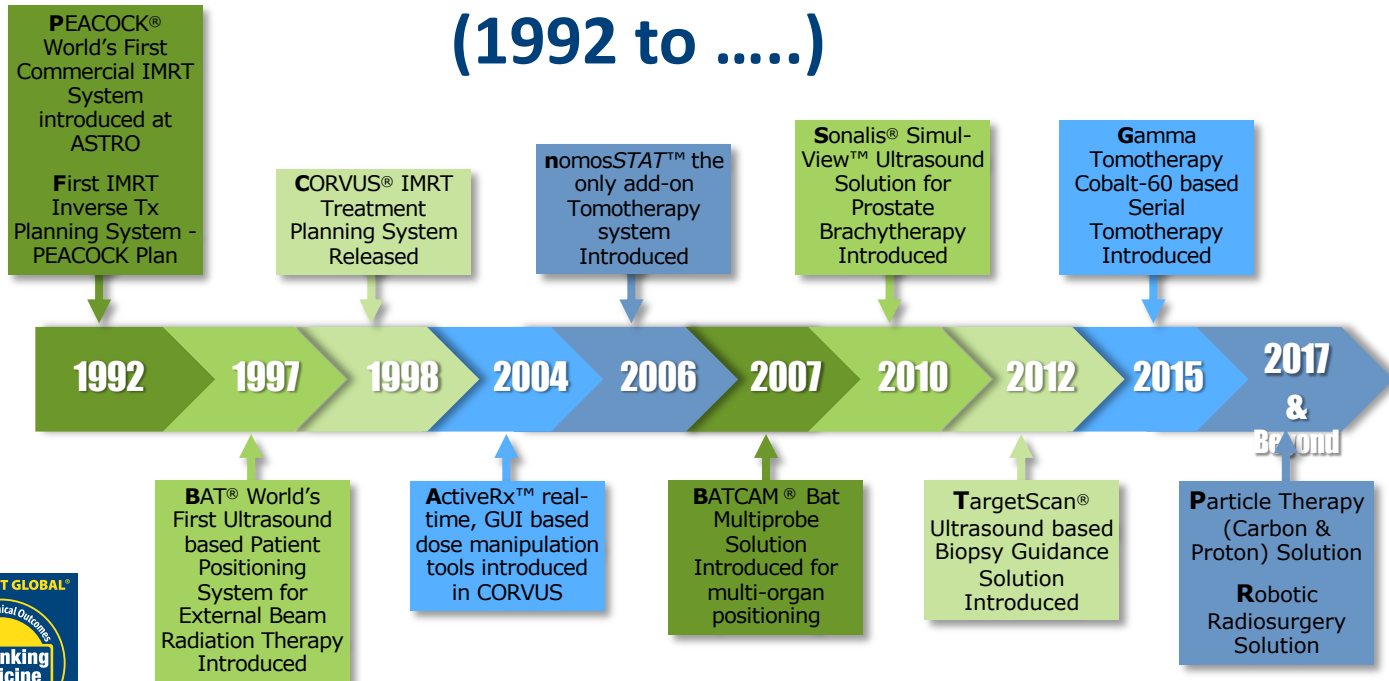



JUN 4 1993

Food and Drug Administration
1390 Piccard Drive
Rockville, MD 20850Sankara Ramaswamy
Research Scientist
Best Industries, Inc.
7643 Fullerton Road
Springfield, Virginia 22153Re: K924261/B
Radioactive Cesium Seeds/Sources
Dated: April 28, 1993
Received: April 29, 1993
Regulatory Class: II
21 CFR 892.5730

Dear Mr. Ramaswamy:

We have reviewed your Section 510(k) notification of intent to market the device referenced above and we have determined the device is substantially equivalent to devices marketed in interstate commerce prior to May 28, 1976, the enactment date of the Medical Device Amendments. You may, therefore, market the device, subject to the general controls provisions of the Federal Food, Drug, and Cosmetic Act (Act). General controls provisions of the Act include requirements for registration, listing of devices, good manufacturing practice, labeling, and prohibitions against misbranding and adulteration.

If your device is classified (see above) into either class II (Special Controls) or class III (Premarket Approval) it may be subject to such additional controls. Existing major regulations affecting your device can be found in the Code of Federal Regulations, Title 21, Parts 800 to 895. In addition, the Food and Drug Administration (FDA) may publish further announcements concerning your device in the Federal Register. Please note: this response to your premarket notification submission does not affect any obligation you might have under the Radiation Control for Health and Safety Act of 1968, or other Federal Laws or Regulations.

This letter immediately will allow you to begin marketing your device as described. A FDA finding of substantial equivalence for your device to a legally marketed predicate device results in a classification for your device and permits your device to proceed to the market, but it does not mean that FDA approves your device. Therefore, you may not promote or in anyway represent your device or its labeling as being approved by FDA. If you desire specific advice on the labeling for your device, please contact the Division of Compliance Operations, Device Labeling Compliance Branch (HFZ-326) at (301) 427-1342. Other general information on your responsibilities under the Act, may be obtained from the Division of Small Manufacturers Assistance at their toll free number (800) 638-2041 or at (301) 443-6597.

Sincerely yours,

Lillian Yin, Ph.D.
Director, Division of Reproductive,
Abdominal, Ear, Nose and Throat,
and Radiological Devices
Office of Device Evaluation
Center for Devices and
Radiological Health



CVO-2000 Warming Oven for Thermoplastics



MANUFACTURED AND ASSEMBLED IN THE USA

Fixed Red or Green Diode Lasers



Best™ NOMOS Treatment Planning System (TPS)

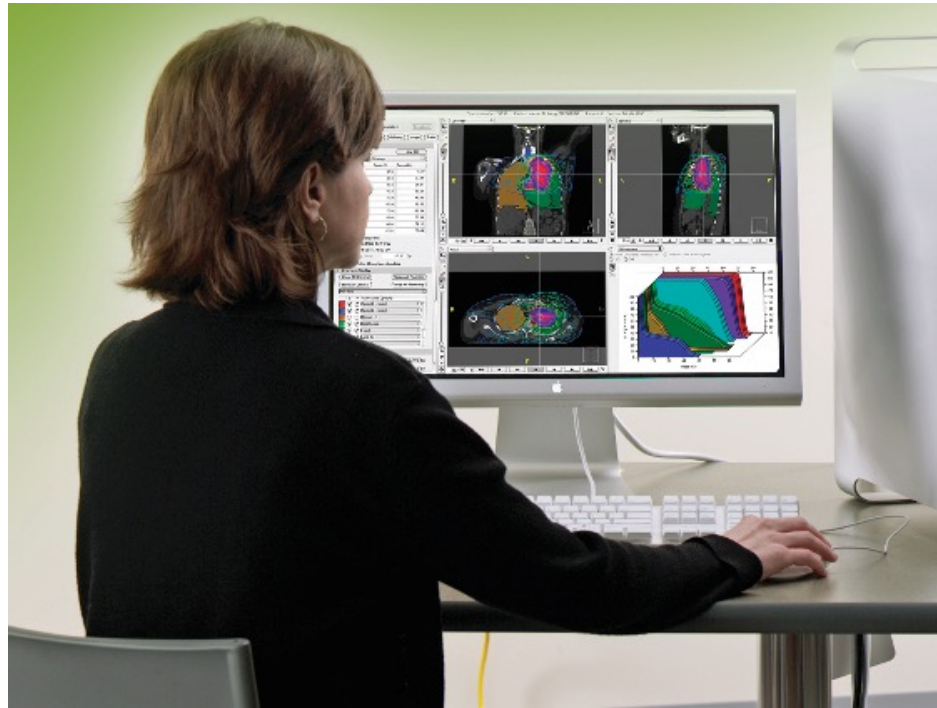

Best™ NOMOS Treatment Planning System (TPS)

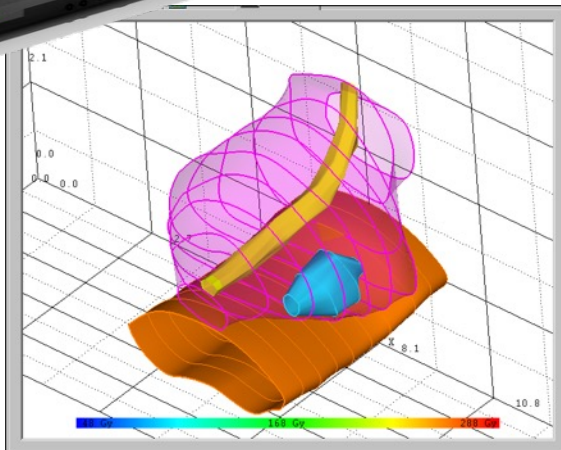

Laptop based TPS:

- Concurrent 2D/3D Visualization
- Easy to use GUI workflow
- Planning templates

Future Directions:

- Pathology mapping/octant dosimetry
- Integrated data flows between pathology and treatment planning

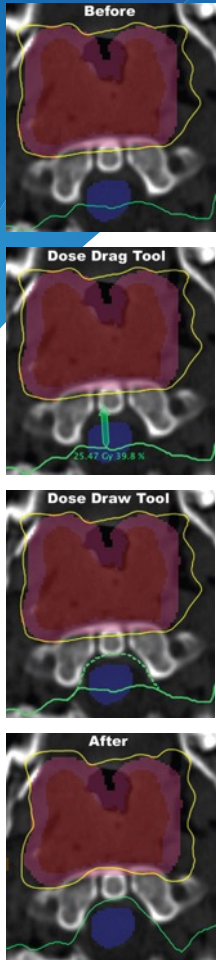

Features Not Found on any other IMRT Treatment Planning System

ActiveRx Shows the Implications of Dose Adjustments in Minutes

When a physician asks for a change in the treatment plan using a variety of on-screen dose adjustment tools, ActiveRx immediately shows the implications of that change. Even for complex IMRT treatments, where thousands of beams are used, ActiveRx produces results in minutes. This allows clinicians to quickly understand the subtle interplays of competing goals and move directly to the point of best balance for their patients.

Patient Treatment

CORVUS creates plans that can be delivered on virtually all OEM MLCs, both static and dynamic delivery, and provides the horsepower to plan for the highly conformal demands of serial tomotherapy delivery.

AccuBoost[®]

Partial Breast Radiotherapy





Raycell[®] Mk2 Blood Irradiator

Treatment of Graft-Versus-Host Disease (TA-GVHD) is almost always ineffective, and therefore management must focus on prevention by minimizing the risk of developing the condition. Blood irradiation using the Raycell[®] Mk2 uses two opposing x-ray tubes to deliver superior uniform dose.



X-ray Blood Irradiator—Raycell® CE

The Raycell® CE X-ray Blood Irradiator is an ideal alternative for smaller facilities with on-site blood processing requirements. It demands minimal administration and achieves comparable throughput to other self-contained irradiator systems. And, Raycell® CE is available right in the lab where you need it.



Raycell[®] Mk1 X-ray Blood Irradiator

Effective, convenient and user friendly, the Raycell[®] Mk1 X-ray Blood Irradiator provides a safe and cost-effective choice for blood irradiation—back by Best Theratronics' trusted expertise and commitment to quality.





Raycell[®] X40 Research Irradiator

- X-ray version of the Gammacell[®] 40 Exactor
- Delivers a central dose of ~1.5 Gy/min
- 8.0 L sample container
- Excellent dose uniformity
- Self-contained cooling system—no external water required

Best™ NOMOS Precision Stepper-Stabilizer

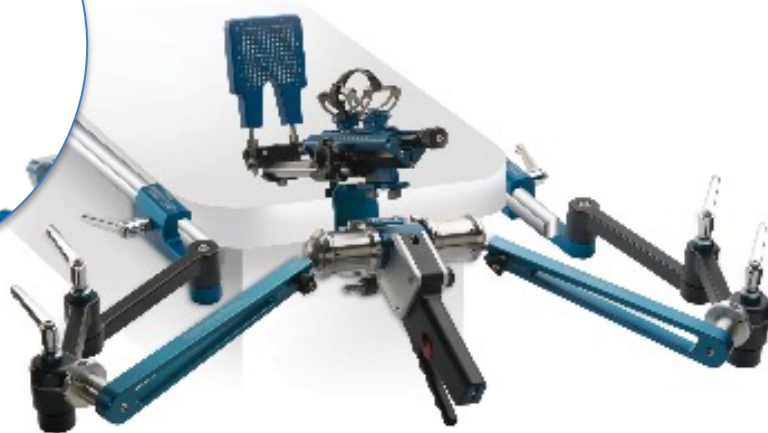

Feature	Serial Tomotherapy (nomosSTAT™)	Helical Tomotherapy (Tomotherapy®)	Remarks
Delivery	Serial (slice) tomotherapy delivers a cylinder of radiation by rotating a binary collimator around the patient; then the table is moved a fixed amount and another cylinder is delivered, repeatedly in a serial fashion until the entire region is treated. Beam is off when table is moving.	Helical (spiral) tomotherapy delivers radiation by rotating a binary collimator around the patient with simultaneous movement of the table while the beam is on, delivering a helical, screw-thread type pattern.	Serial tomotherapy allows control of beam intensities for each slice being treated.
Treatments	Coplanar and non-Coplanar treatments (treat difficult tumors by “kicking” the couch)	Coplanar treatments only (as the linear accelerator is in a ring gantry which leads to fixed couch/gantry relationship)	With nomosSTAT you can treat isocentrally and non-isocentrally, an advantage for treatment of tumors in critical locations
Energy	Can be installed on various LINACs with different energies	6 MV photons only	nomosSTAT works with almost any accelerator and Equinox Cobalt-60 Teletherapy system. It is an add on package to upgrade the accelerators.
Service	Can be removed for servicing	Entire system is down	Treatment Systems can be used for conventional therapy with nomosSTAT in service
Cost	\$\$	\$\$\$\$\$	nomosSTAT provides better options at lower cost

Best™ Nomos TargetScan Touch

Ultrasound-based transrectal
and transperineal biopsy system
for prostate cancer diagnosis

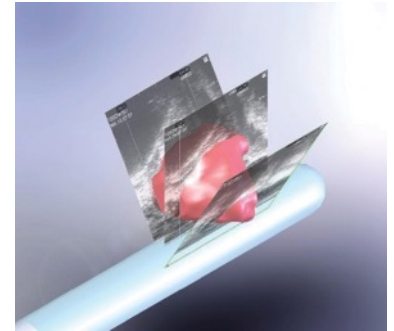

Certain products shown are not available for sale currently.





*Best*TM
Cyclotron Systems

A T E A M B E S T G L O B A L C O M P A N Y

B100 Cyclotron	7.5 MeV	<ul style="list-style-type: none"> • Capable of producing: ^{18}FFDG and Na^{18}F • Single or batch dose production • Integrated self-shielded cyclotron, chemistry module and FDG QC module • Complete production lab in a 5 x 5 meter area
BG-95 Cyclotron	1-9.5 MeV	<ul style="list-style-type: none"> • Low energy, self-shielded compact system capable of producing: ^{18}FFDG, Na^{18}F, ^{18}F-MISO, ^{18}FFLT, ^{18}F-Choline, ^{18}F-DOPA, ^{18}F-PSMA, ^{13}N and ^{68}Ga
Best Cyclotrons	1-3 MeV	<ul style="list-style-type: none"> • Deuterons for materials analysis*
	70-200 MeV	<ul style="list-style-type: none"> • For Proton Therapy*
	3-90 MeV	<ul style="list-style-type: none"> • High current proton beams for neutron production and delivery*
B6-15 Cyclotron	1-15 MeV	<ul style="list-style-type: none"> • Proton only, capable of high current up to 1000 Micro Amps, for medical radioisotopes
B25 Cyclotron	20, 15-25 MeV	<ul style="list-style-type: none"> • Proton only, capable of high current up to 1000 Micro Amps, for medical radioisotopes
B25u-35adp Cyclotron	25-35 MeV	<ul style="list-style-type: none"> • Proton or alpha/deuteron/proton, capable of high current up to 1000 Micro Amps, for medical radioisotopes
B35 Cyclotron	15-35 MeV	<ul style="list-style-type: none"> • Proton only system for medical radioisotopes production
B70/70adp Cyclotron	35-70 MeV	<ul style="list-style-type: none"> • Proton only or alpha/deuteron/proton systems, capable of high current up to 1000 Micro Amps, for medical radioisotopes

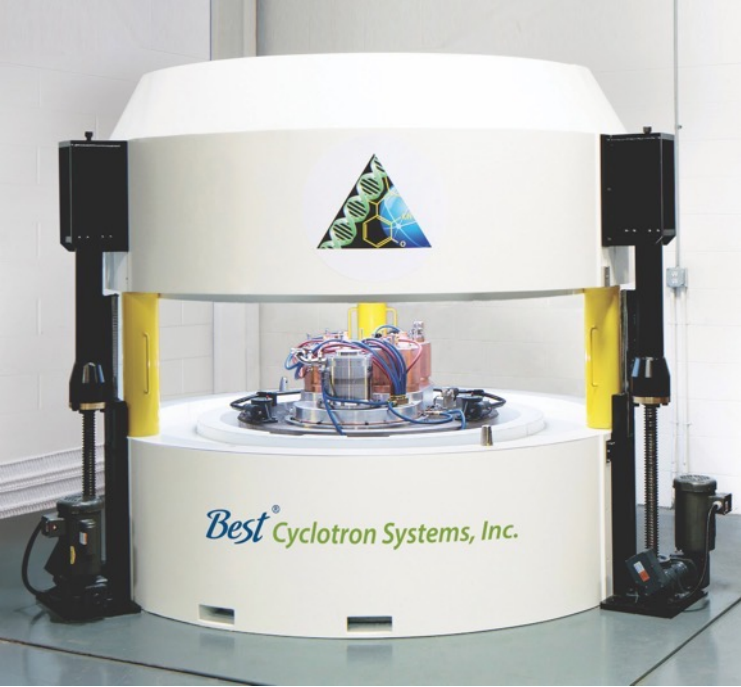

Best™ Model BG-95 Sub-Compact Self-Shielded Cyclotron w/Optional Second Chemistry Module & Novel Target

Best™ 70 MeV Cyclotron at INFN, Legnaro, Italy

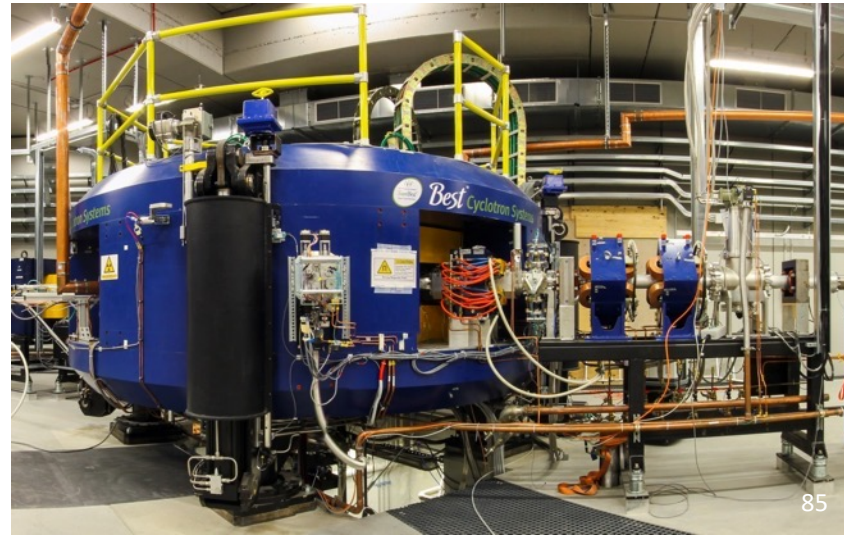

PET and TC^{99m}

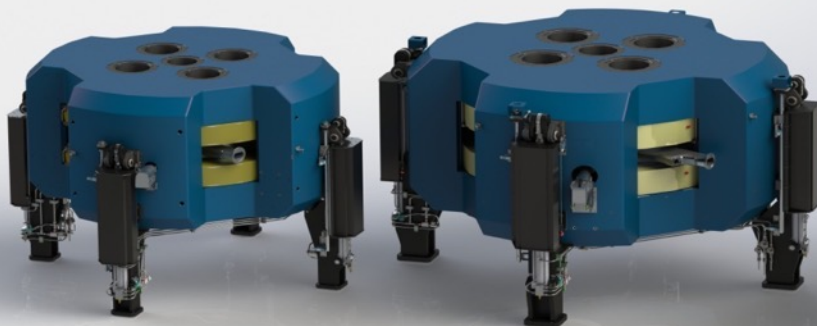
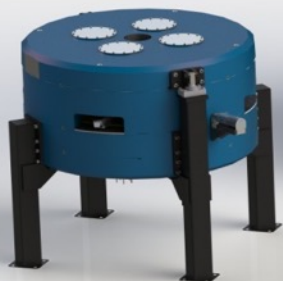

SPECT Radioisotopes

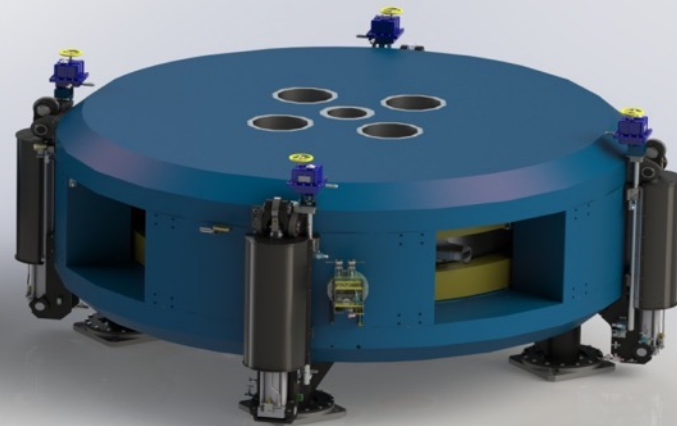

Radiotherapeutics and Generators

B15p PET
15 MeV
400 μ A +
Targets Radiochemistry

B20u/25p
20/15-25 MeV
400 μ A +
Targets Radiochemistry

B30u/35p
30/15-35 MeV
400/1000 μ A
Targets Radiochemistry

B70p
35-70 MeV
1000 μ A
Targets Radiochemistry



Each cyclotron allows production access to special radioisotopes

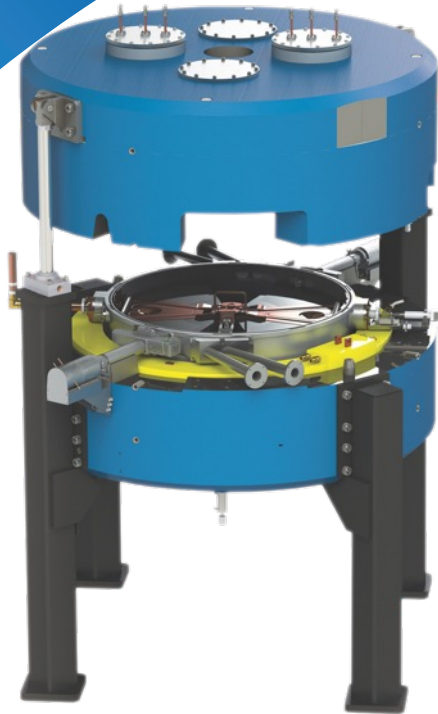

Best 6–15 MeV Compact High Current/Variable Energy Proton Cyclotron

- 1–1000 μA extracted beam current
- Capable of producing the following isotopes: ^{18}F , ^{68}Ga , ^{89}Zr , $^{99\text{m}}\text{Tc}$, ^{11}C , ^{13}N , ^{15}O , ^{64}Cu , ^{67}Ga , ^{111}In , ^{124}I , ^{225}Ac and ^{103}Pd
- Up to 5×10^{13} neutrons per second from external target
- 21 stripping foils at each stripping port for 2 minute rapid change



Best Model B35adp Alpha/ Deuteron/Proton Cyclotron for Medical Radioisotope Production & Other Applications

- Proton Particle Beam: 1000 μA Beam
Current up to 35 MeV Energy
- Deuteron Particle Beam: 500 μA Beam
Current up to 15 MeV Energy
- Alpha Particle Beam: 200 μA Beam
Current up to 35 MeV Energy

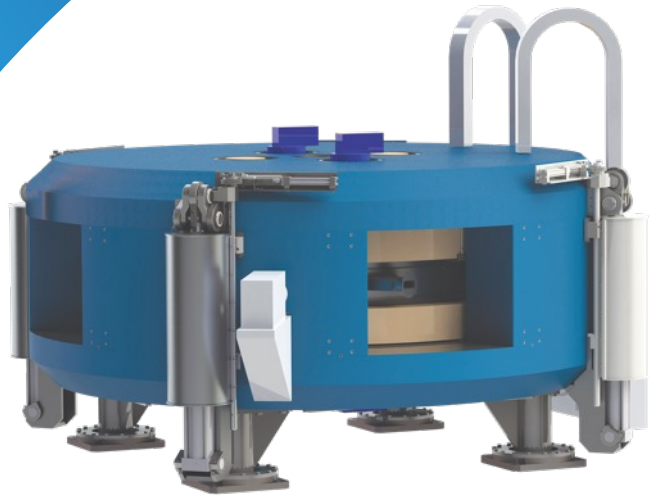

Best 70 MeV Cyclotron Ideal for Sr-82/Rb-82 Supply and Research

- 70-35 MeV variable energy H- cyclotron
- 700 μA extracted beam current (upgradable to 1000 μA)
- 2 simultaneous extracted beams
- Multiple independent beam lines and target positions

Installation of 70MeV Cyclotron

May 2015 • Legnaro, Padova, Italy



Installation of 70MeV Cyclotron

May 2015 • Legnaro, Padova, Italy



70 MeV Cyclotron at INFN

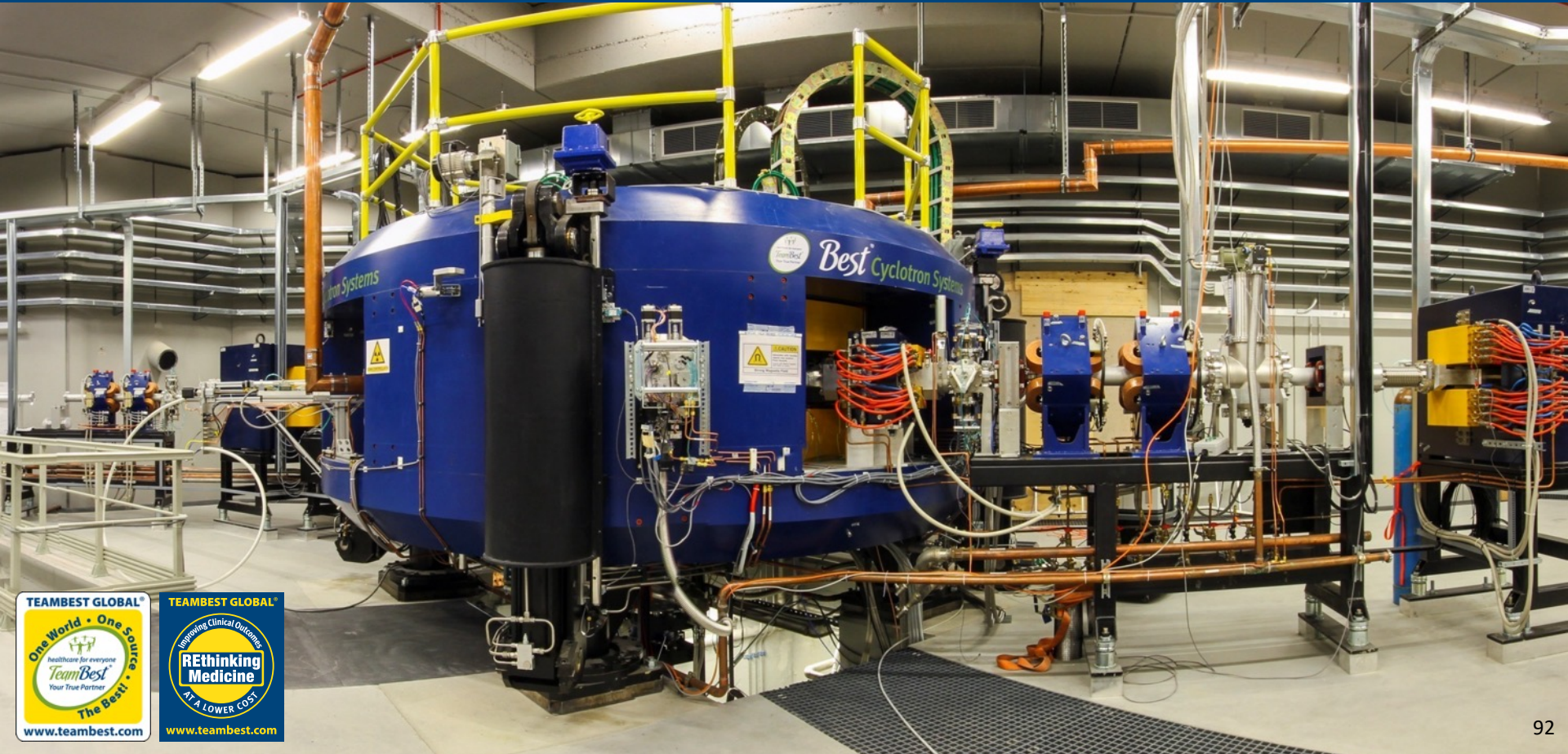

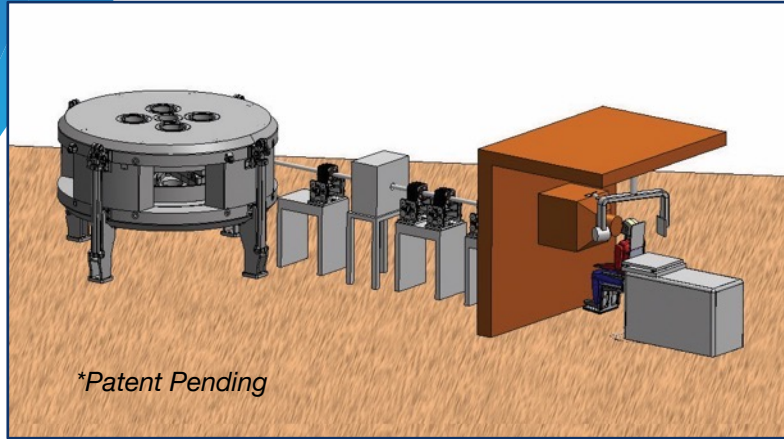

Best Model 200p Cyclotron for Proton Therapy*

- From 70 MeV up to 200 MeV Variable Energy
- Dedicated for Proton Therapy with two beam lines and two treatment rooms
- For all Medical Treatments including: Benign and Malignant Tumors, Neurological, Eye, Head/Neck, Pediatric, Lung Cancers, Vascular/Cardiac/Stenosis/Ablation, etc.

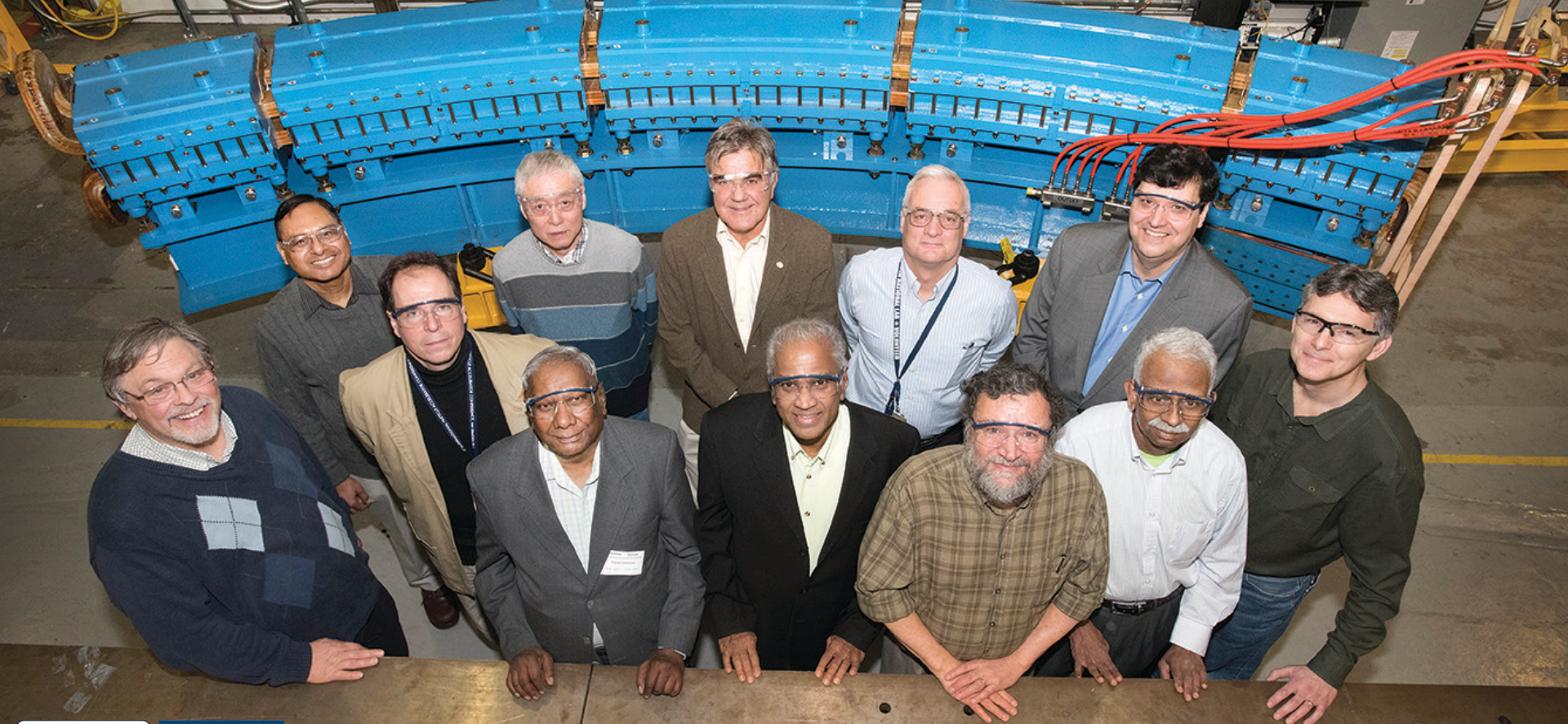

iRCMS Magnet at BNL





*Best*TM **ABT**

Molecular Imaging

A TEAMBEST GLOBAL COMPANY

Best ABT Press Release

November 12, 2018

TeamBest Companies enters agreement to acquire ABT Molecular Imaging, Inc. and announces creation of Best ABT, Inc.

Best Medical International, Inc. (BMI) and Best Cyclotron Systems (BCS) both part of the TeamBest group of companies, are pleased to announce the creation of Best ABT, Inc. Best ABT, Inc. has entered into an agreement to acquire ABT Molecular Imaging, Inc. (ABT), a Knoxville, TN based cyclotron manufacturing company.

(continued)

Best ABT Press Release

(continued from previous slide)

The TeamBest group of companies, founded by Krishnan Suthanthiran, is headquartered in Springfield, Virginia, USA, and manufactures a variety of quality products for the radiation therapy and diagnostic community.

BCS currently offers a wide array of cyclotrons ranging from 15 MeV to 70 MeV. A fully-functioning Best 70 MeV cyclotron has been successfully installed in Legnaro, Italy. BCS is currently installing several other cyclotrons in various countries worldwide.

Best ABT, Inc. will be a valuable addition to the TeamBest cyclotron portfolio that will allow TeamBest to deliver quality oncology diagnosis and care to a large group of currently underserved patients worldwide. The acquisition of ABT will bring a wealth of experience in smaller cyclotron technology, as well as in automated chemistry to TeamBest.

Best ABT Press Release

(continued from previous slide)

The cyclotron manufactured by ABT, the BG-75 Biomarker Generator (BG-75 System) is smaller and easier to install and operate than most conventional systems. The BG-75 integrates a compact cyclotron with micro-chemistry and automated quality control system, to provide on-demand F-18 FDG production in one seamless solution (“Dose-On-Demand”) to support the diagnostic community. With more than 25 BG-75 Systems sold worldwide, Best ABT, Inc. will allow the TeamBest group of companies to expand its global reach into more diverse markets than ever before.

With this acquisition, TeamBest is taking another step in delivering on its promise to deliver “healthcare for everyone”. Together with Best Cure Foundation (BCF), the TeamBest group of companies will set up a hub-and-spoke model healthcare delivery system, linked to General, as well as Super-Specialty Medical Centers, availing themselves of all of TeamBest’s new and advanced technologies worldwide.



Best ABT Molecular Imaging

The BG-75 Biomarker Generator is a revolutionary development in radio-pharmaceutical production that delivers a single or batch dose of ^{18}F -FDG, and additional advanced ^{18}F biomarkers, “on demand.” The system provides integration of all components needed to produce and qualify PET biomarkers into a single, self-contained system that occupies a fraction of the space required by conventional solutions, simplifying the implementation of PET.





Best ABT Molecular Imaging

The BG-75 Biomarker Generator integrates a compact mini-cyclotron, kit based micro-chemistry, and automated quality control, simplifying in-house production of ^{18}F -FDG and advanced biomarkers.

- Push button graphic interface
- Kit based chemistry
- Single or batch dose production
- Final dose delivery to syringe or vial (option)
- Automated quality control testing
- Integrated cyclotron & chemistry self-shielding
- Complete production lab in a 30²m area

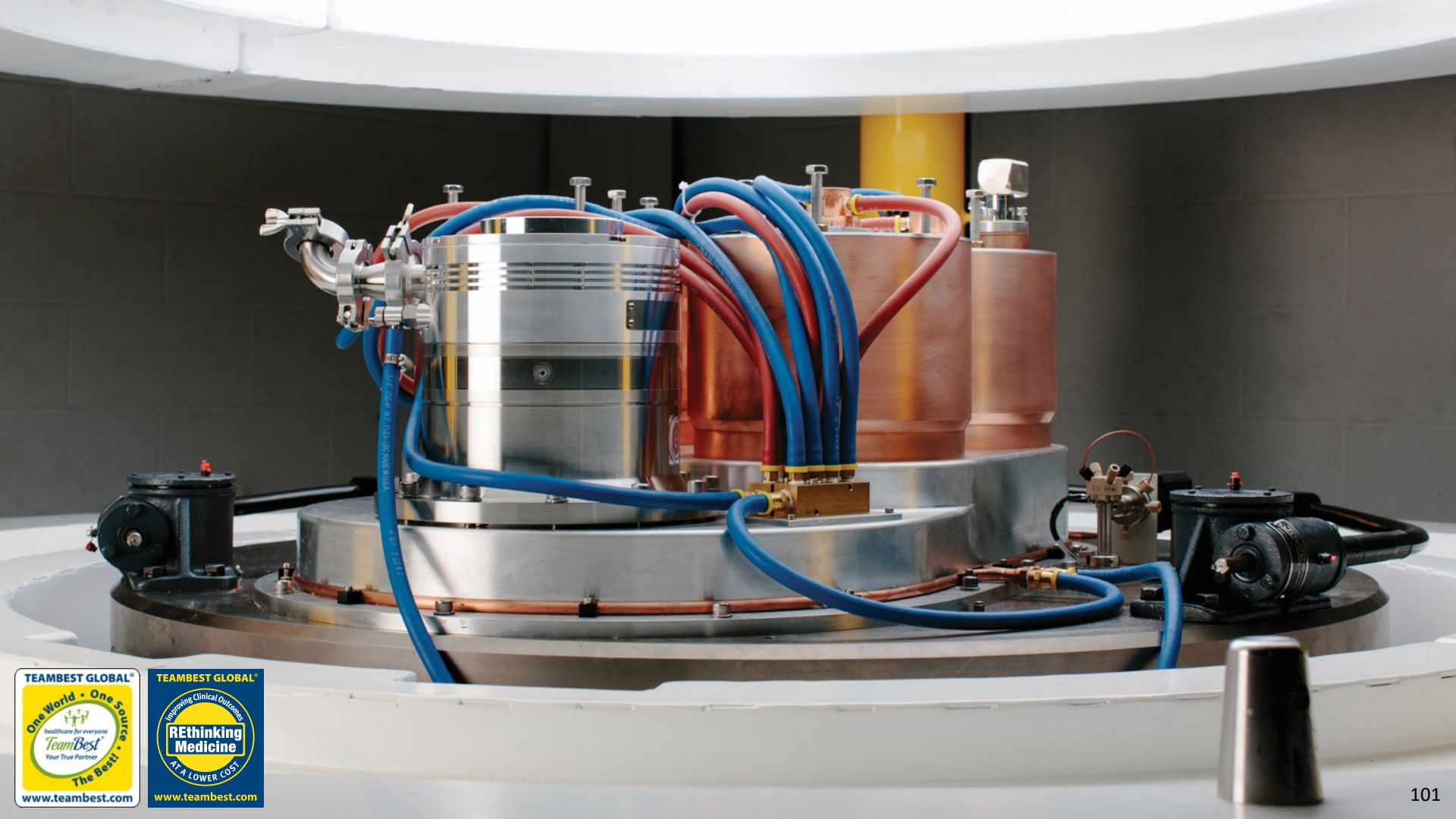



*Best*TM
Theratronics

A TEAMBEST GLOBAL COMPANY

Best GammaBeam™ 300-100 CM Equinox™ Teletherapy System with Avanza 6D Patient Positioning Table

The **GammaBeam™ 300-100 CM Equinox™** is an evolution of the Theratron line of treatment devices. The advanced design provides freedom in treatment planning and can interface to all of the major record/verify systems to allow for rapid treatment parameter loading, treatment set-up verification and the recording of delivery.



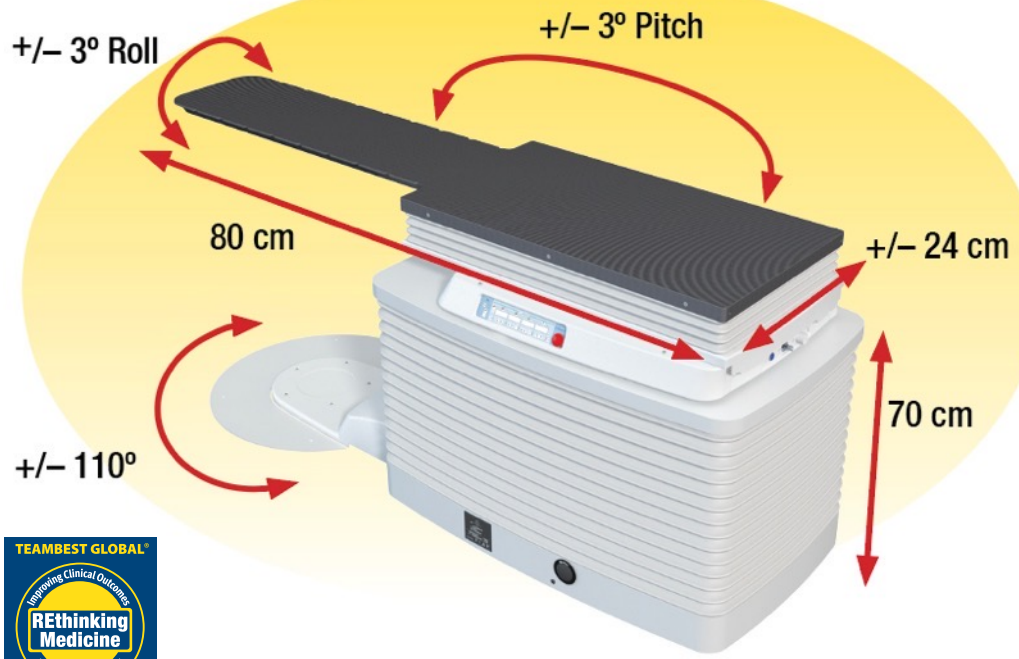

Avanza 6D Positioning Table

NEW Avanza 6D table provides adjustment in all six dimensions—including pitch and roll—greatly improving the patient set-up for all treatment cases.



Avanza™ Patient Positioning Table

The **Avanza™ Patient Positioning Table** demonstrates a high level of stability and accuracy for treatment techniques that require precision.



- Accurate and reproducible patient positioning
- Better than 2 mm positioning accuracy
- Efficient and comfortable patient set-up
- Flexible set-up with “zero” position
- Streamlined set-up with free-float and automated motions
- Kevlar mesh reduces surface dose buildup

GammaBeam™ 300-100 CM Equinox™

- High activity sources
1.5 or 2 cm diameter
- 390 cGy/min at 80 cm
- 250 cGy/min at 100 cm
- Asymmetric collimators
- Auto Set-Up
- Physical Wedges
(15, 30, 45 and 60 degrees)
- Collision Detection
- Service Diagnostics
- Motorized Wedge
(1 to 60 degrees)
- Wedge and Block Code
Interlock
- Fixed Beam and Arc
Treatment
- Beam Stopper Option
- In-Room Monitors
- On-board Treatment
Verification
- Ergonomic Hand Control
- Dual Computer Control
System
- Graphical Data Entry
Interface

NEW! Multi-Leaf Collimator for 80 and 100 cm SAD units— IMRT, IGRT, SRS, SBRT and Tomotherapy capable with ActiveRx

- **Machine Verification:** Parameters Set and Actual are continually monitored by the machine to ensure accuracy.
- **Asymmetric Jaws:** Partial fields capable without manual blocking. This feature saves time and reduces the handling requirements of manual block trays.
- **Auto Setup:** One-button setup and patient loading decreases the time required to prepare patients for treatments.
- **Motorized Wedges:** 60° Wedge moves in and out of field allowing therapists to block fields simply and effortlessly.

*Certain products shown are not available for sale in certain countries. © 2023



A **Multi-Leaf Collimator** is available as an optional accessory for the Equinox product line, providing 3D Conformal Radiation Therapy (3D CRT) and Intensity Modulated Radiation Therapy (IMRT) capability. The intuitive user interface incorporates a patient database, record and verify functionality, and is DICOM-RT compatible for treatment plan imports.

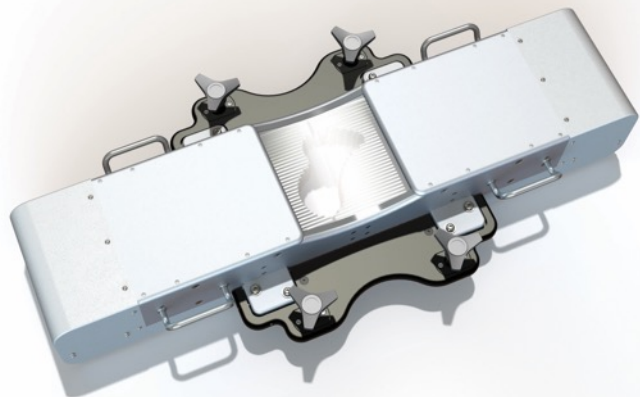

The **Equinox MLC 60** system is the most advanced Cobalt Teletherapy system available.

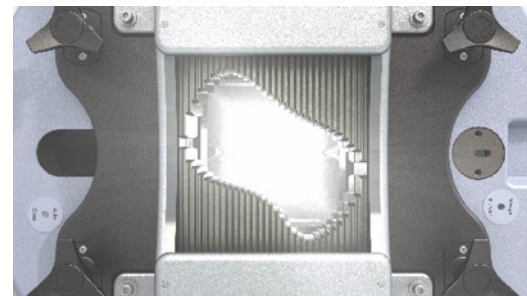

GammaBeam™ 100-80 CM



The **GammaBeam™ 100-80 CM** is a highly practical model of the GammaBeam family of External Beam Therapy System (EBTS). Convenience and safety, combined with simplicity of design, make it easy to use and easy to maintain. Particularly appropriate for treatment centers requiring extended hours of daily operation and where budgetary considerations are a major concern.



Manual Multi-Leaf Collimator

A manually adjustable multi-leaf collimator is now available with the GammaBeam™ 100-80 CM product line. The innovative concept of the MMLC system now provides the ability to conform the Cobalt-60 Radiotherapy to the exact tumor shape without the cumbersome use of lead blocks. The method known as 3D CRT, improves the impact on the cancerous tissue while sparing the surrounding healthy tissue. The MLC connects modern treatment methods in radiotherapy with high cost-efficiency and maximum reliability for all environments.

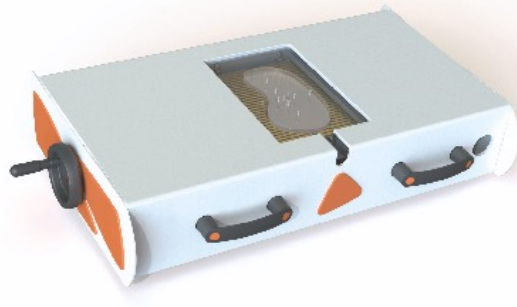
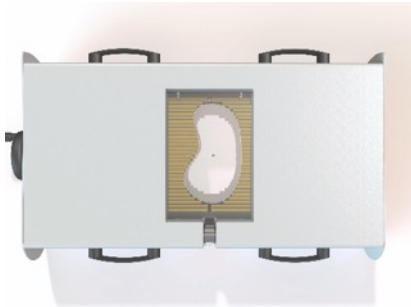



Total Body Irradiator GammaBeam™ 500

The **Total Body Irradiator GammaBeam™ 500** is a teletherapy unit designed to produce a large fixed rectangular radiation field at an extended source-to-skin distance in order to deliver total body irradiation. The unit can also be used for research and dosimetry purposes. Features include: dose rate up to 40 cGy/min at 2.5 m in air, record and verify and imaging capabilities, graphical touch screen data entry interface and motorized vertical motion of the head.





Patient Positioning Couch

The patient couch is an accessory of the GB500, which includes an integrated portal imaging detector option. The imaging sub-system allows position verification of organ a tenuators, used during AP/PA total body irradiation treatments.

Comparative Analysis of ^{60}Co Intensity-Modulated Radiation Therapy

Christopher Fox, H Edwin Romeijn, Bart Lynch, Chunhua Men, Dionne M Aleman, and James F Dempsey
Phys Med Biol. 2008 Jun 21;53(12):3175-88.

Abstract: In this study, we perform a scientific comparative analysis of using ^{60}Co beams in intensity-modulated radiation therapy (IMRT). In particular, we evaluate the treatment plan quality obtained with (i) 6 MV, 18 MV and ^{60}Co IMRT; (ii) different numbers of static multileaf collimator (MLC) delivered ^{60}Co beams and (iii) a helical tomotherapy ^{60}Co beam geometry. ... The results of the investigation demonstrate the potential for IMRT radiotherapy employing commercially available ^{60}Co sources and a double-focused MLC. Increasing the

number of equidistant beams beyond 9 was not observed to significantly improve target coverage or critical organ sparing and static plans were found to produce comparable plans to those obtained using a helical tomotherapy treatment delivery when optimized using the same well-tuned convex FMO model. While previous studies have shown that 18 MV plans are equivalent to 6 MV for prostate IMRT, we found that the 18 MV beams actually required more fluence to provide similar quality target coverage.



For the full article, please visit www.gammatherapy.com

Cobalt-60: An Old Modality, A Renewed Challenge

Jake Van Dyk and Jerry J. Battista

Current Oncology, November 1995

Abstract: The discovery of x-rays and radioactivity 100 years ago has led to revolutionary advances in diagnosis and therapy. However, it was not until the middle of the twentieth century that megavoltage photon energies became available through the use of betatrons, cobalt-60 gamma rays and linear accelerators (linacs). The increased photon penetration and skin sparing provided radiation oncologists with new opportunities for optimizing patient treatments. In recent years, several reports have considered various issues which define the “optimum” photon energy for the treatment of malignant disease. In many of these articles, cobalt-60 is mentioned although it is generally not recommended for radiation therapy departments in the western world. Indeed, many now consider cobalt-60 as an old modality

that is only useful for palliative treatments in a large department or for developing countries with limited technical resources. ... In this commentary, we ... briefly review the arguments that have been presented both for and against the use of cobalt-60 as well as add some up-to-date insights and perspectives. Undoubtedly, we will not resolve this debate for all clinical situations. However, we hope that by putting “*all* the cards on the table”, the cobalt-60 option will be viewed from a fairer perspective than we have seen in recent years of rapidly advancing accelerator technology. Furthermore, we also make some recommendations for the designers of cobalt-60 technology so that modernized units can be made more attractive for today’s radiation therapy facility.



For the full article, please visit www.gammatherapy.com

Best Theratronics Ltd Machine Shop, Ottawa, Canada



Best Theratronics Ltd Assembly Hall, Ottawa, Canada



TEAMBEST GLOBAL®



www.teambest.com



*Best*TM
Particle Therapy

A TEAMBEST GLOBAL COMPANY

Collaboration with the Best in the World

In 2009, **Best Medical International (BMI)** and **Brookhaven National Laboratory (BNL)** signed an agreement called **CRADA** (**C**ooperative **R**esearch **A**nd **D**evelopment **A**greement)

The mandate was to develop an
ion **R**apid **C**ycling **M**edical **S**ynchrotron (**i**RCMS)



BNL (USA) Particle Accelerators 0.75 MeV to 250 GeV



Proton therapy precisely targets tumors, reducing the radiation dose to healthy tissue compared with X-rays¹

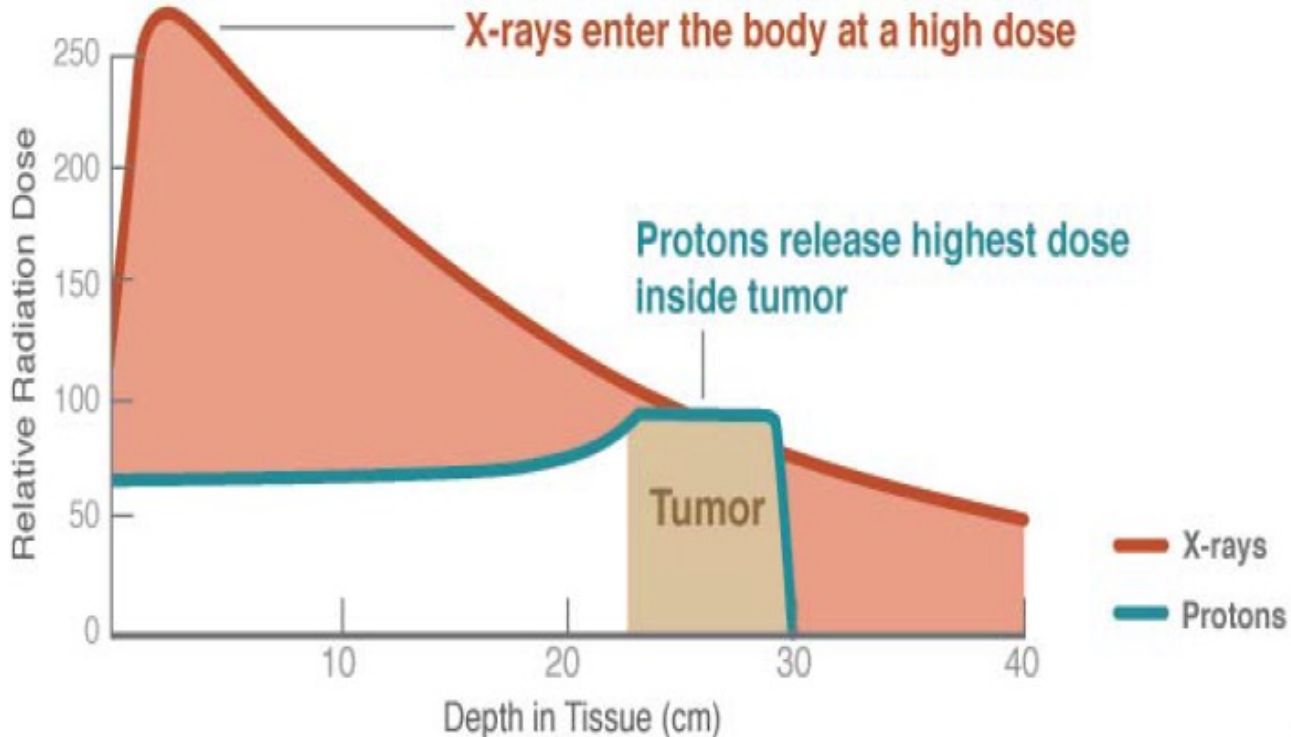

1946 "Radiological Use of Fast Protons" and discovery of the Bragg Peak

ROBERT R. WILSON  Research Laboratory of Physics, Harvard University

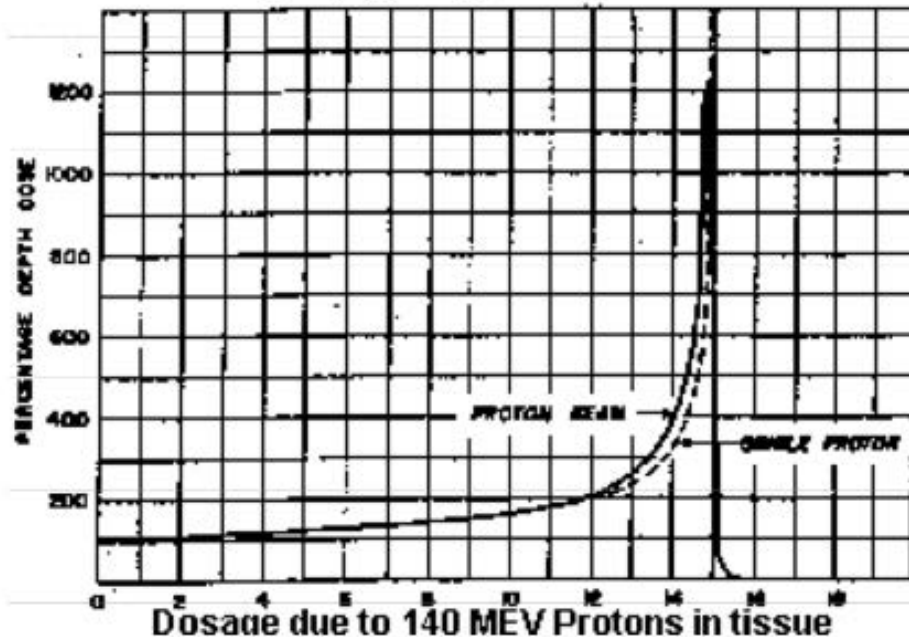

High energy dose at the end of path (**Bragg peak**)

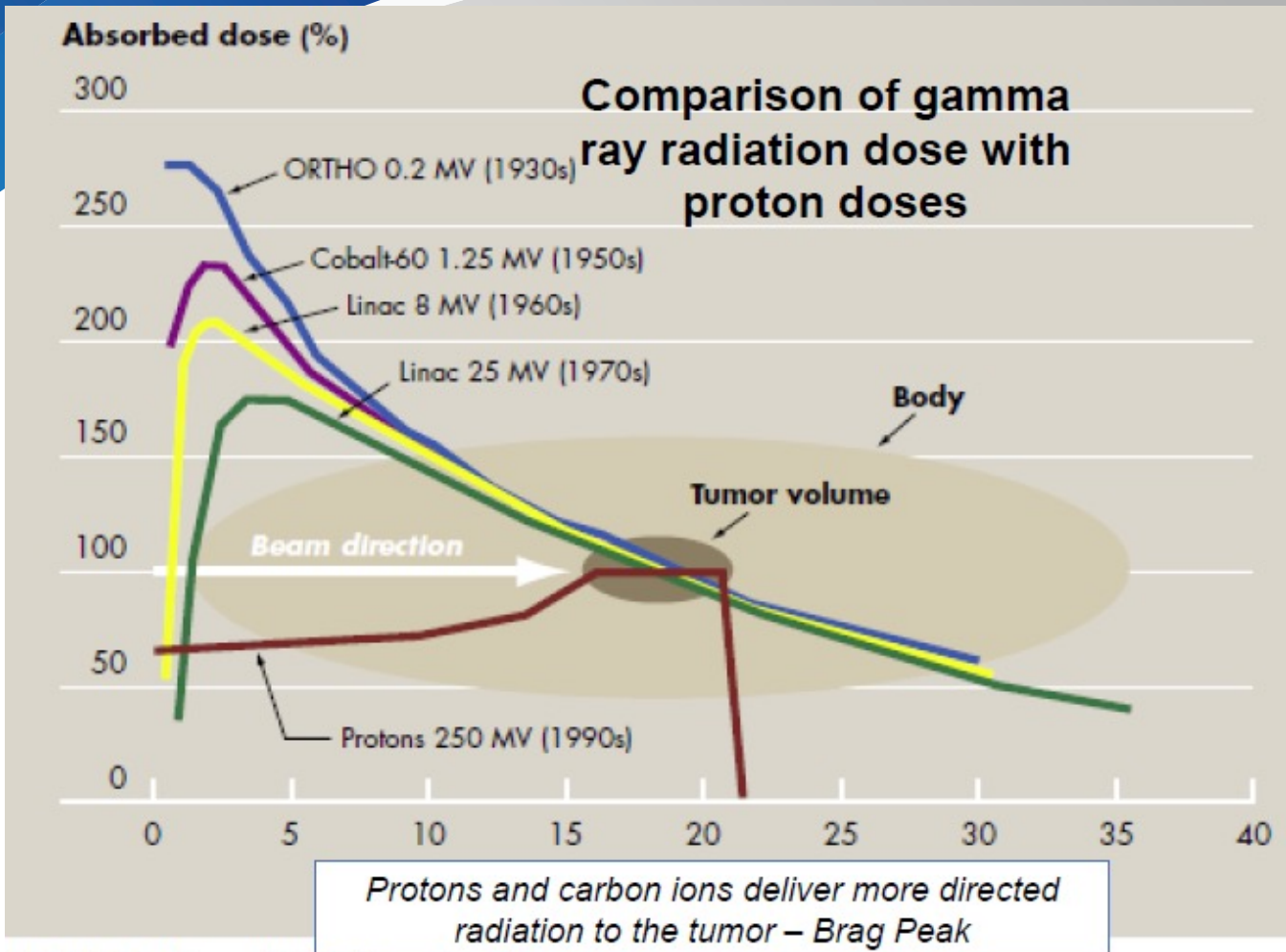
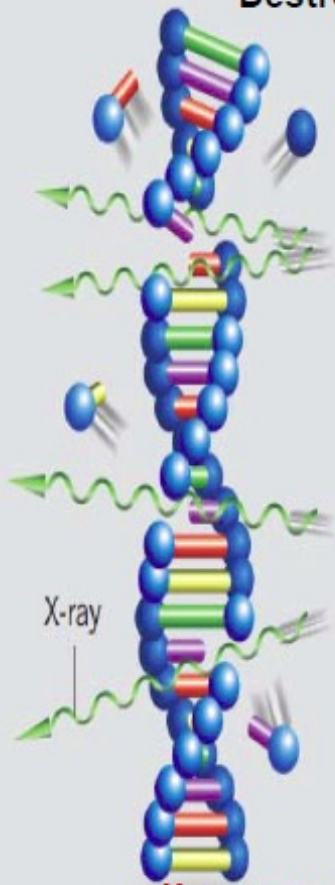

FIGURE 1 Dose distribution of protons versus x-rays.

Destroying Cancer DNA



DNA



X-ray versus Proton versus Carbon

Minor Damage done by Protons are reversible

Carbon chops up the DNA and does irreparable damage

X-ray

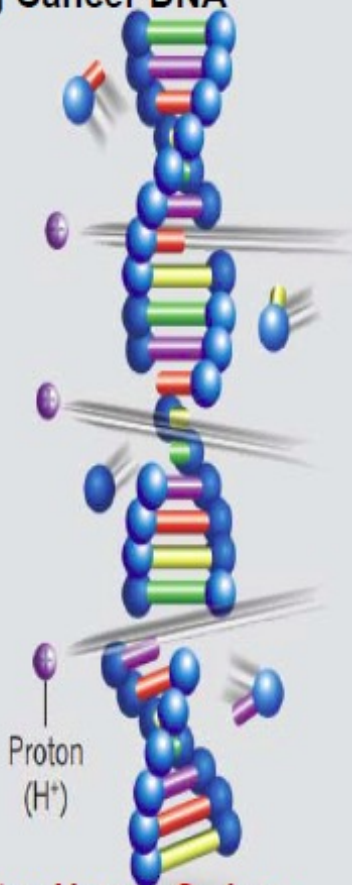

Proton beam

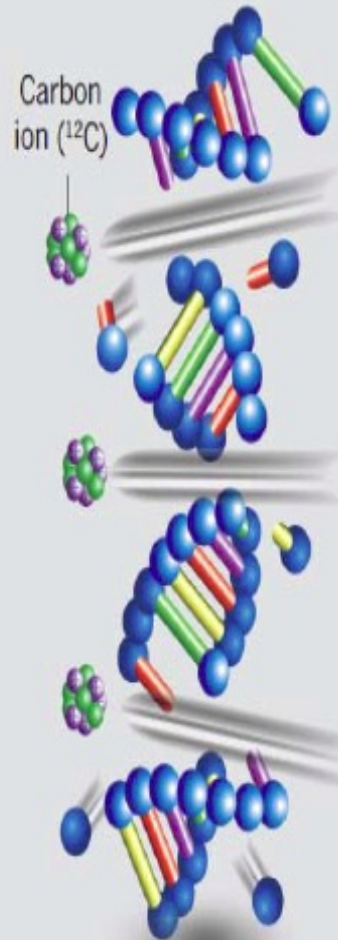

Carbon-ion beam

Typical Treatment Room

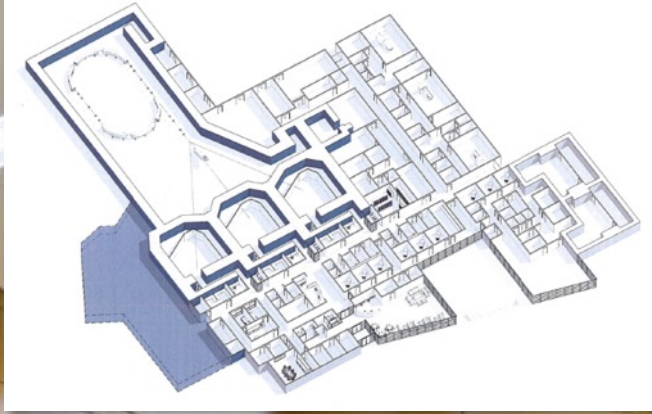

Single-Room Solution



Supine CT Verification

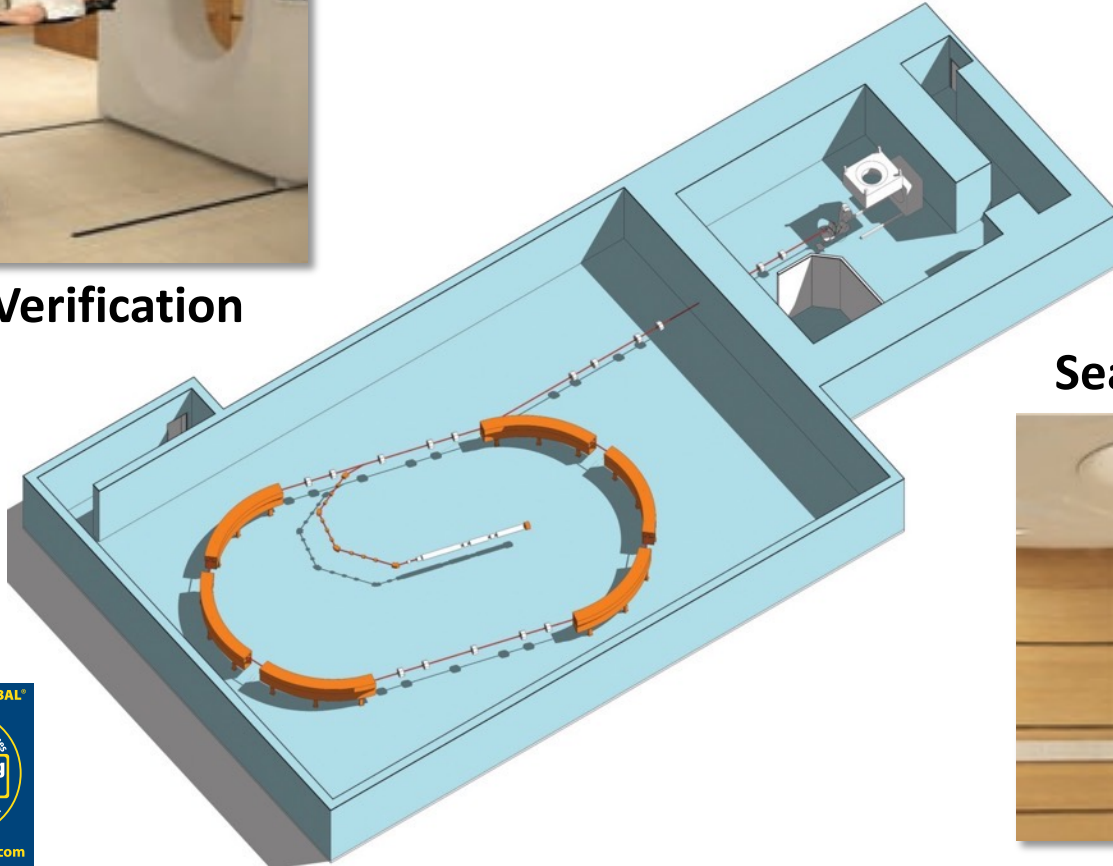

Seated CT Verification



Expandable from Single-Room to Multi-Room

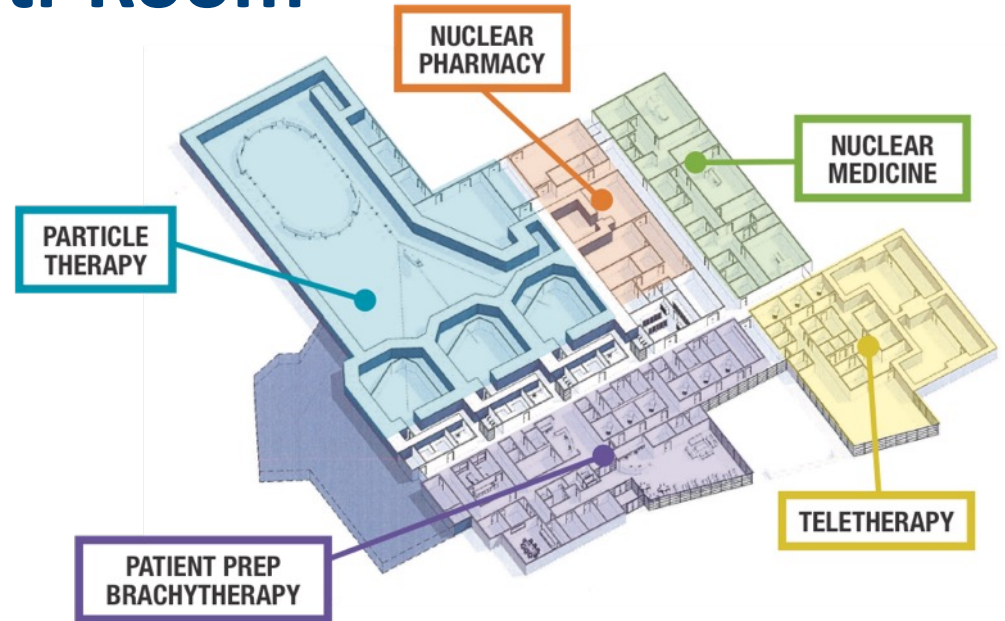
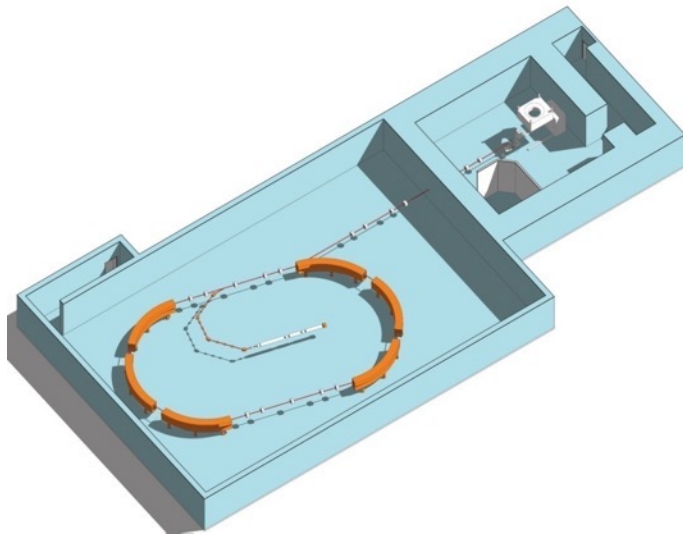

BEST / BNL iRCMS – Much Smaller Footprint

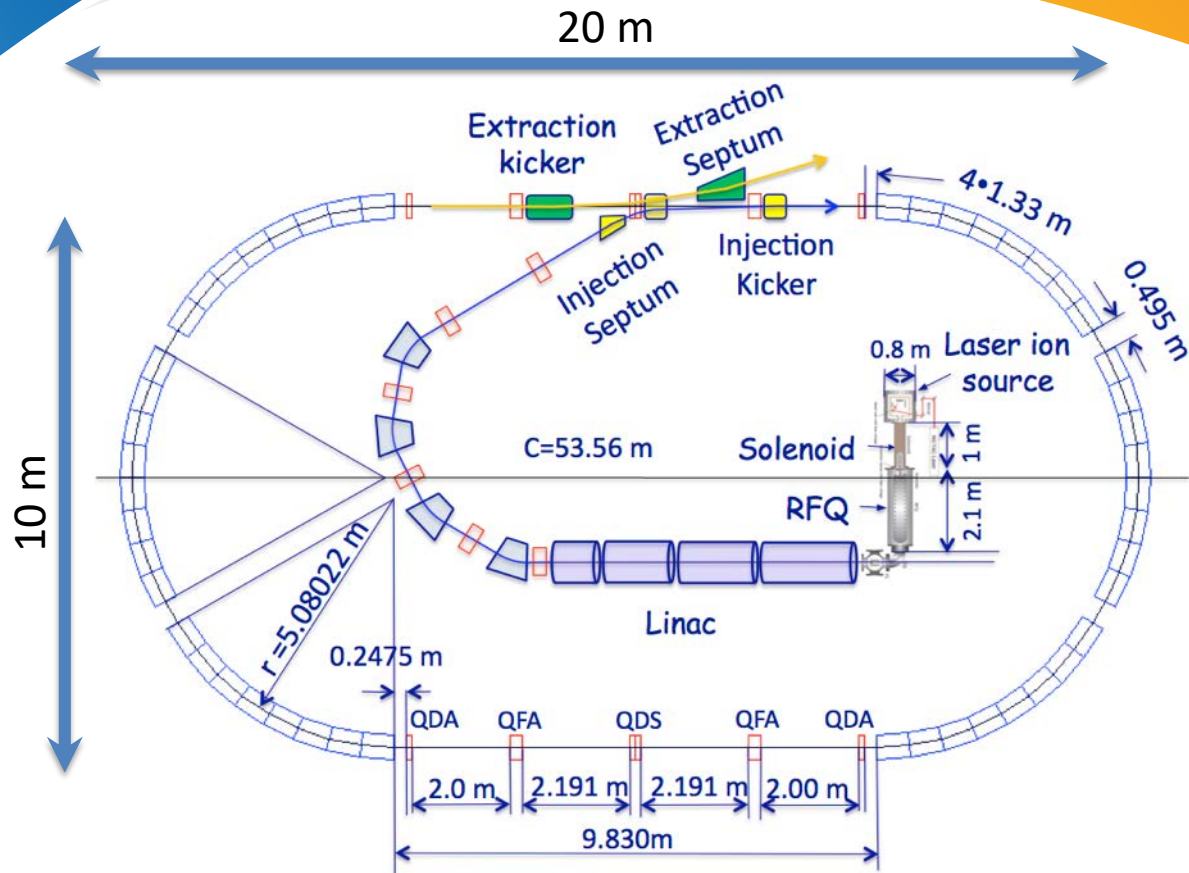

Racetrack Synchrotron

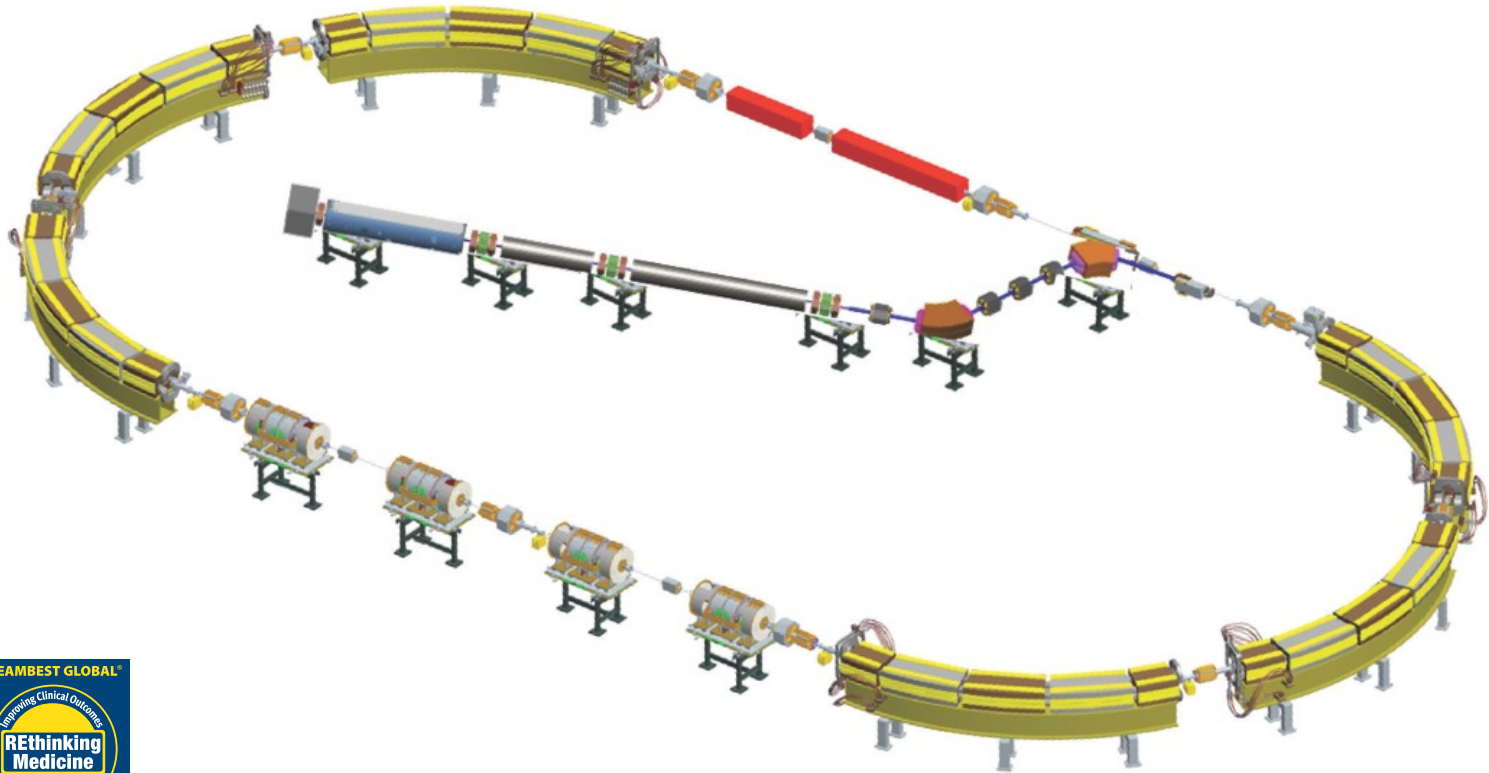

RBE: Relative Biological Effectiveness

OER: Oxygen Enhancement Ratio

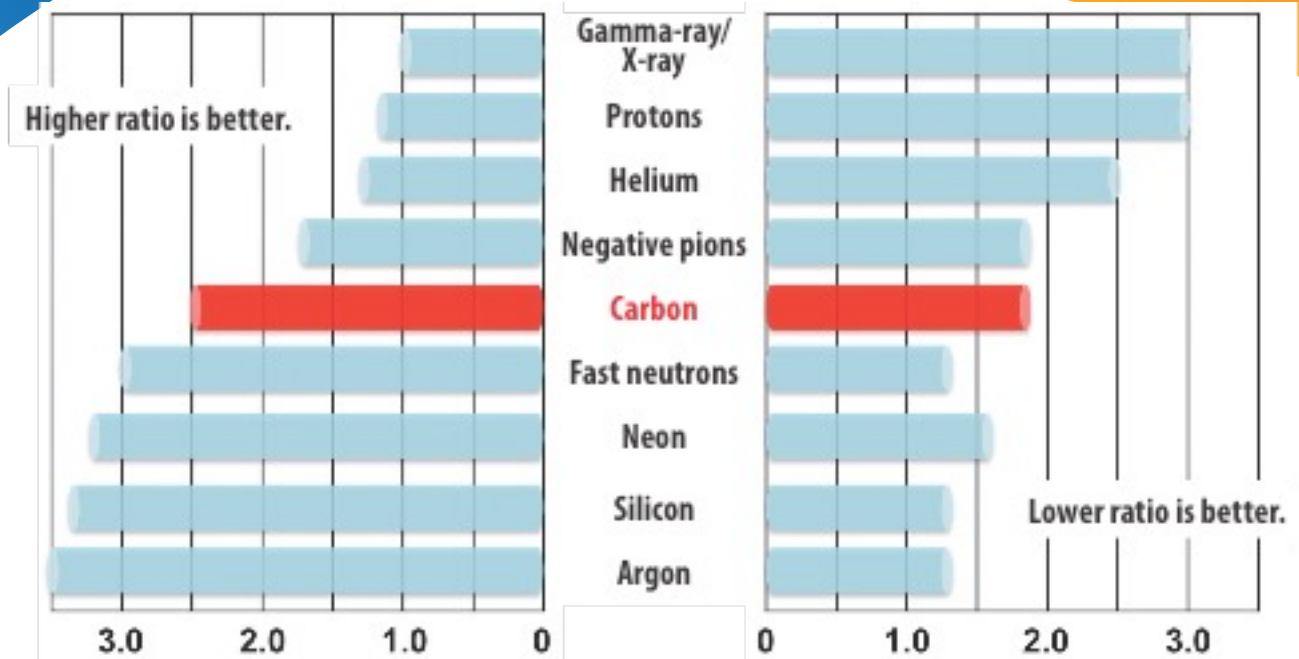

RBE represents the biological effectiveness of radiation in the living body. The larger the RBE, the greater the therapeutic effect on the cancer lesion.

OER represents the degree of sensitivity of hypoxic cancer cells to radiation. The smaller the OER, the more effective the therapy for intractable cancer cells with low oxygen concentration.

Clinical Comparison: X-rays vs. Protons vs. Carbon Ions

Peak-to-Plateau ratio of the RBE (a/b) is larger
in carbon ion beams than for proton beams.

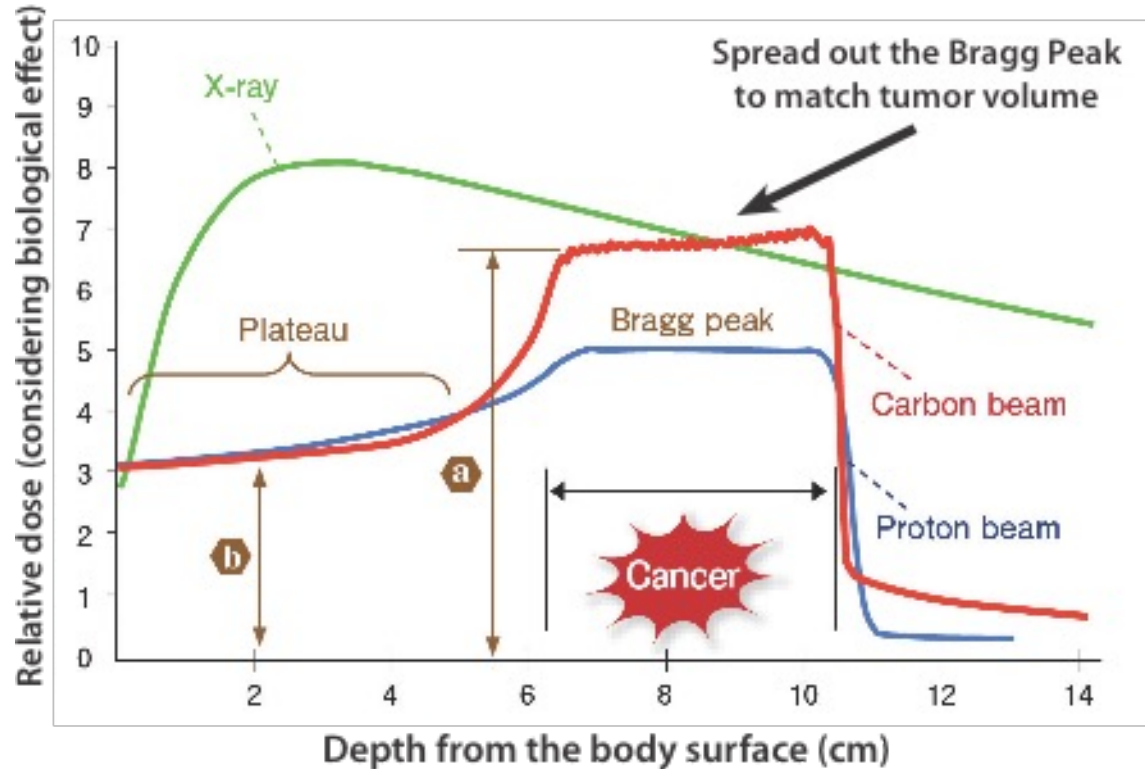

Graph courtesy of
Hirohiko Tsujii et al.,
Radiological Sciences,
50(7), 4, 2007

Carbon Ions are more precise than Protons

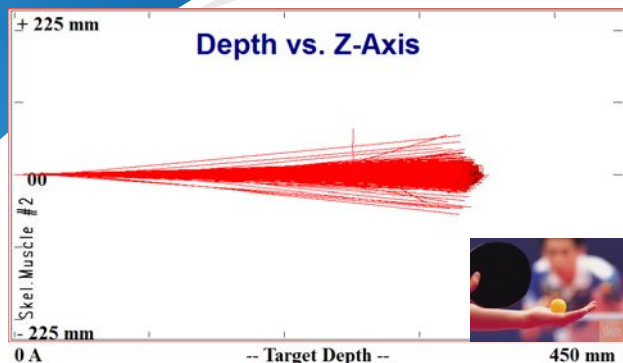

The intrinsic spot width for ~ 206 MeV/u protons is $2\sigma = 11.4$ mm

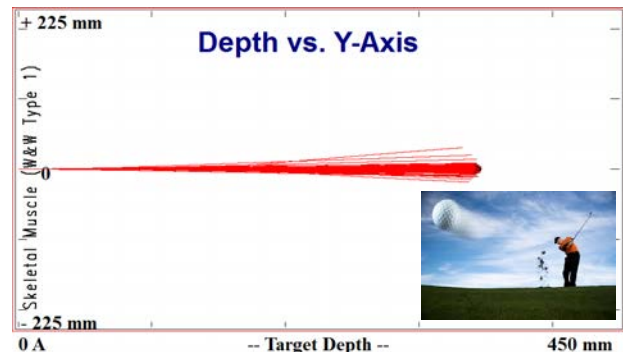

The intrinsic spot width for ~ 400 MeV/u carbon ions is $2\sigma = 2.93$ mm

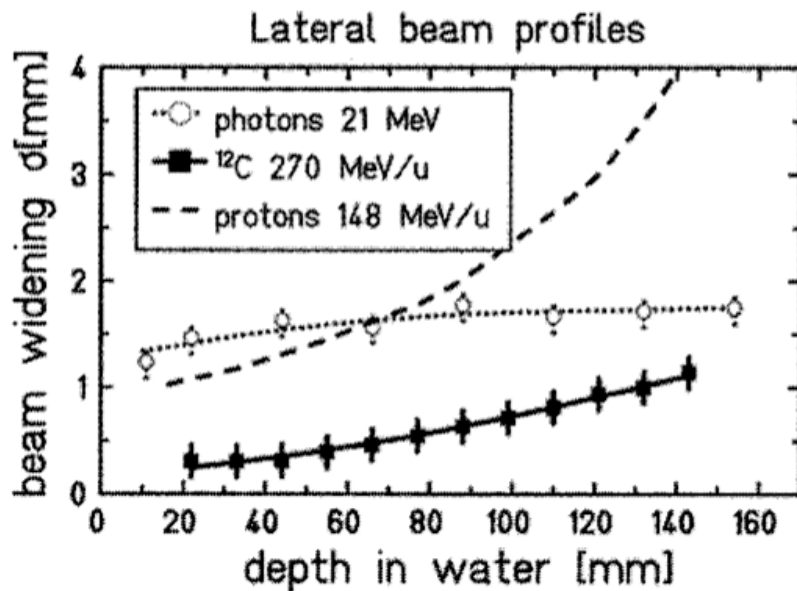

“Lines to guide the eye”
U. Weber GSI (1996)

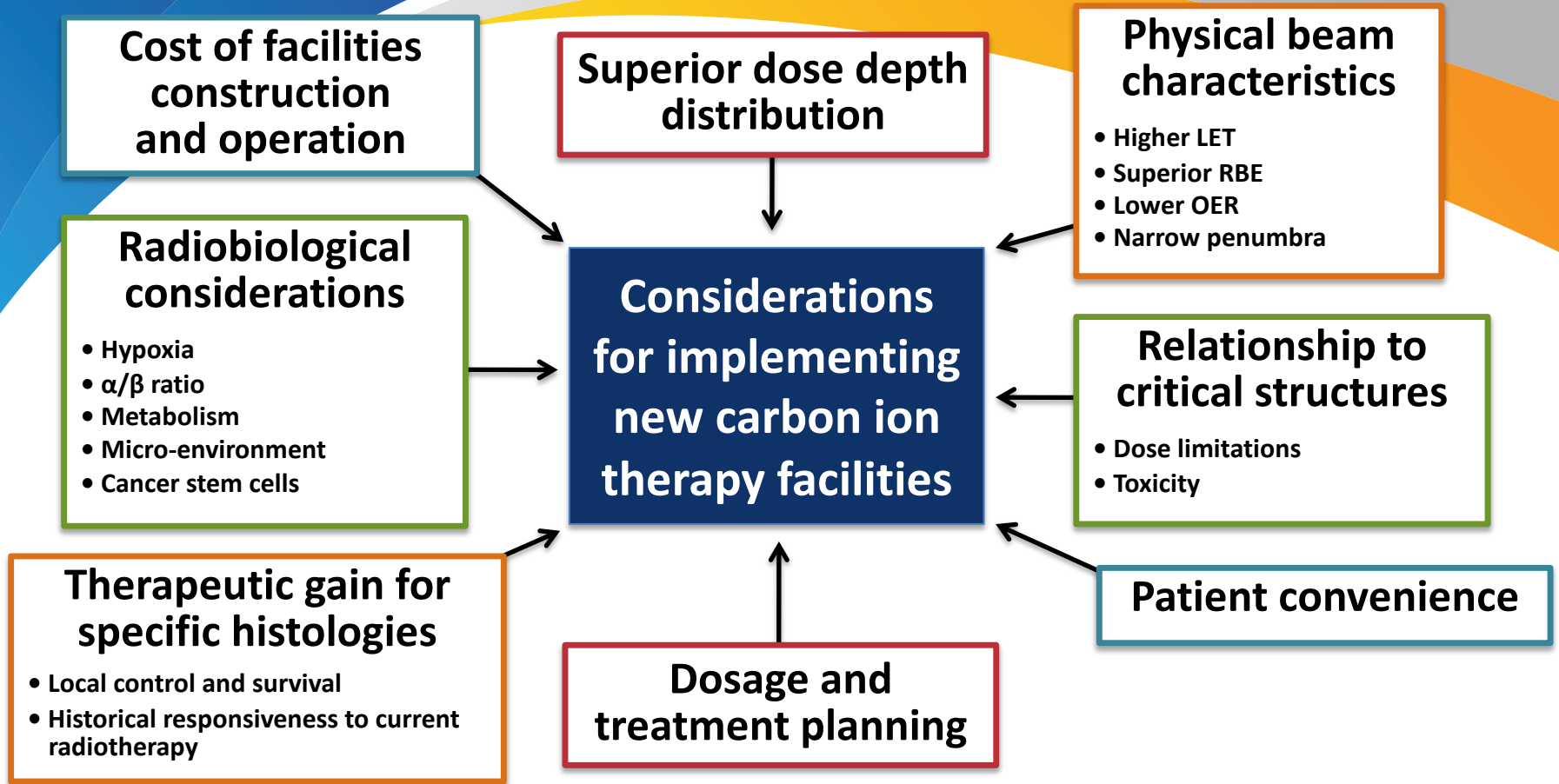

Medical Advantage

- Deliver 20 times the cancer killing power of protons
- Cure the patient 4 to 10 times faster

Benefit to Patient

- Shorter treatment times – potentially 4 to 10 times less
- Less stress for the patient physically, emotionally & financially
- Less unnecessary radiation exposure

Benefit to Society

- A Heavy Ion Center will provide maximum advantage to the general public by having the capability to treat many more patients than a Proton Center with the same number of treatment rooms

Best Supplies Proton Systems Upgradeable to Helium and Carbon!

State of the Art Manufacturing Facilities



**Best NOMOS (Pittsburgh, PA) &
Best Theratronics (Ottawa, ON)**



Assembly

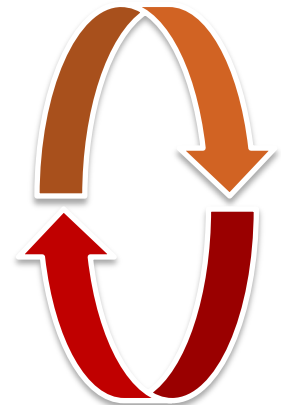

Heavy Manufacturing

Future Development Flash Therapy





Best™ Integrated Radiotherapy Solutions



X-Beam™ Image-Guided
Multi-Energy Linac System



X-Beam™ Robotic
Radiosurgery System



E-Beam™ Robotic IORT
Linac System

The Future of Flash Radiation Therapy

Flash Therapy, first known as Intra Operative Radiation Therapy (IORT), was initiated in the late 1960s by doctors in Japan. IORT is now commonly referred to as Flash Therapy. Doctors in Japan performed the surgery and radiation therapy in two separate locations.

In 1975, at Howard University Hospital in Washington, DC, **the late Dr. Ulrich K. Henschke and his team—which included Dr. Krishnan Suthanthiran, President/Founder of TeamBest Global Companies—became the first to perform both procedures in the same room, advancing Flash Radiation Therapy.**

TeamBest Global Companies plan to introduce a new version of the IORT System/Flash Therapy, utilizing a robot. It's noteworthy that this is the first time a robot has been used, and Best Medical International holds a patent for this Robotic Electron Linac.

Please visit www.teambest.com to find out more.



FLASH THERAPY IN 1975



FLASH THERAPY NOW



KITSAULT ENERGY UPDATE:

WHERE WE STAND TODAY

KRISHNAN SUTHANTHIRAN
FOUNDER & PRESIDENT,
KITSAULT ENERGY





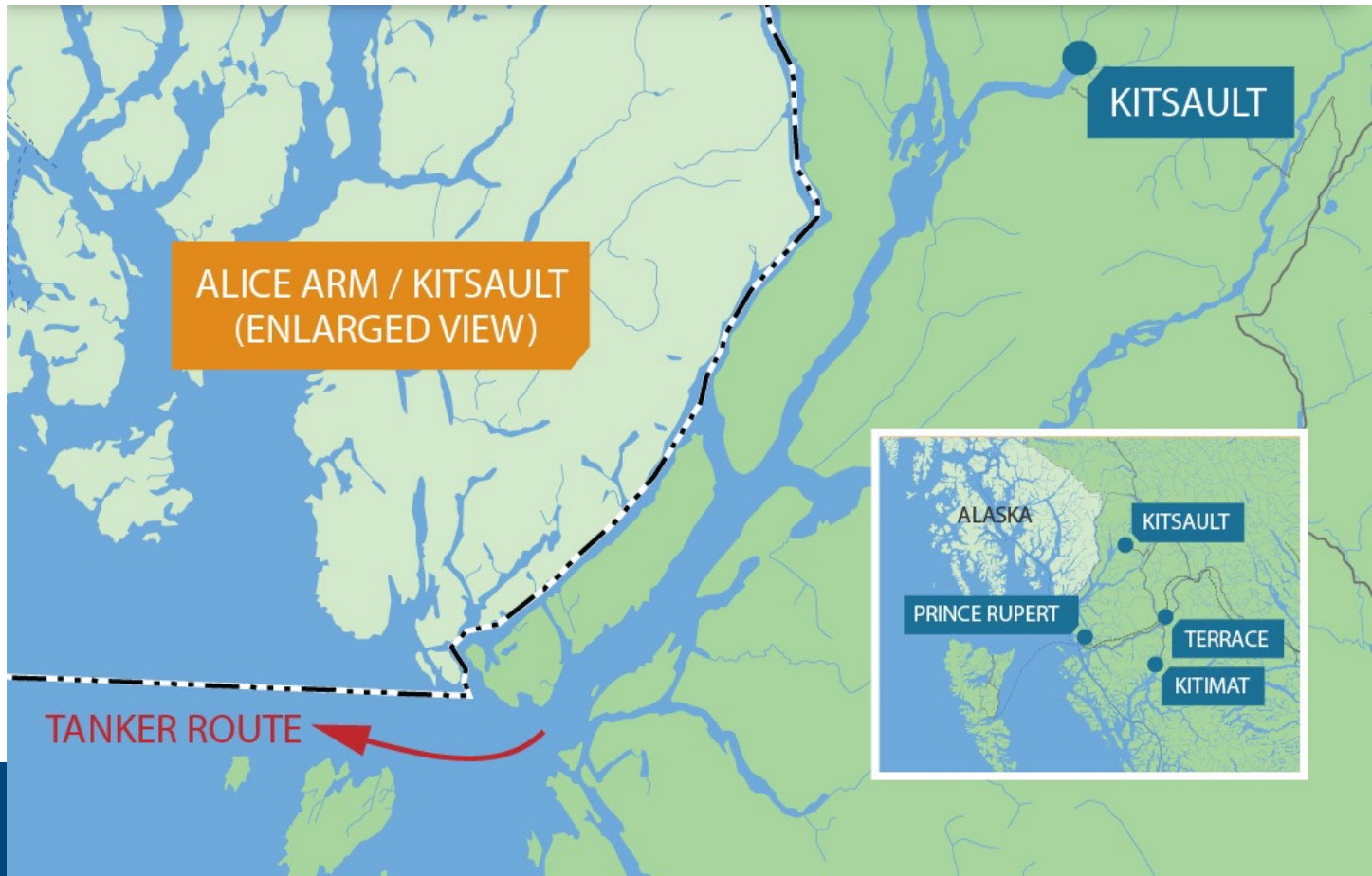





EXISTING HOUSING INFRASTRUCTURE:

SINGLE FAMILY HOMES

- 95 THREE BEDROOM HOMES AVAILABLE.

APARTMENT BUILDINGS

- 150 TWO AND THREE BEDROOM APARTMENTS AVAILABLE.

FUTURE DEVELOPMENT

- 30 BUILDING FOUNDATIONS ALREADY IN PLACE.
- VACANT LAND THE POTENTIAL DEVELOPMENT OF PRIME OCEAN AND MOUNTAIN VIEW LOTS.





COMMUNITY INFRASTRUCTURE:

RECREATION CENTRES

- THE 25,000 SQUARE FOOT COMMUNITY CENTRE.
- FOUR SHEET CURLING RINK, MOVIE THEATRE AND A PUB.

SHOPPING CENTRE

- 22,000 SQUARE FOOT SHOPPING CENTRE WITH A GROCERY STORE, BANK, AND POST OFFICE

EXECUTIVE HOUSE

- VIP GUEST HOUSE WITH 4 BEDROOMS, 5 BATHROOMS AND A BOARDROOM.

MEDICAL CENTRE

FIRE HALL

INDUSTRIAL BUILDINGS





WWW.KITSAULTENERGY.COM

**KITSAULT
ENERGY**
FUELING THE GREEN FUTURE



KITSAULT, BC



WWW.KITSAULTENERGY.COM

 **KITSAULT
ENERGY**
FUELING THE GREEN FUTURE



KITSAULT, BC



WWW.KITSAULTENERGY.COM

An aerial photograph of a scenic landscape featuring a large, calm lake surrounded by dense green forests and rolling hills. A small cluster of houses is visible on the left side of the image.

WHY KITSAULT ENERGY?

An aerial photograph of the Kitsault Energy site, showing a large reservoir surrounded by dense green forest. A road and some buildings are visible on the left side of the reservoir.

ADVANTAGES OF KITSAULT ENERGY AS A DEDICATED ENERGY CORRIDOR AND EXPORT TERMINAL

1. Kitsault is the closest location to the natural gas rich Northeast British Columbia, Canada to establish a Dedicated Energy Corridor, Export Terminal and Port.



ADVANTAGES OF KITSAULT ENERGY AS A DEDICATED ENERGY CORRIDOR AND EXPORT TERMINAL

2. It has the infrastructure, 90 houses (three bedroom with basement) and 150 condos (2–3 bedrooms) to house nearly 1000 residents, along with the necessary Recreation Center, Medical Clinic, Shopping Center, Post Office, Bank, Restaurants, Supermarket, etc. ready to occupy.

An aerial photograph showing a town situated on a peninsula or near a large lake, surrounded by dense green forest. The water is a light blue-green color. The town has several buildings and a road. The forest is very thick and green.

ADVANTAGES OF KITSAULT ENERGY AS A DEDICATED ENERGY CORRIDOR AND EXPORT TERMINAL

3. It has full British Columbia Hydro Power service to the entire town site.

An aerial photograph of a large, calm lake surrounded by dense green forests and rolling hills. A small settlement with several buildings is visible on the left side of the lake. The water is a clear, light blue-green color.

ADVANTAGES OF KITSAULT ENERGY AS A DEDICATED ENERGY CORRIDOR AND EXPORT TERMINAL

4. It can be accessed by road, multiple airports, water, helicopters, float planes, water taxi, etc.

An aerial photograph of a large, calm lake surrounded by dense green forests and rolling hills. A small settlement with several buildings is visible on the left side of the lake. The water is a clear, light blue-green color.

ADVANTAGES OF KITSAULT ENERGY AS A DEDICATED ENERGY CORRIDOR AND EXPORT TERMINAL

5. It has a Deep Water Port for navigation of Tankers, Barges, Ships, etc.

An aerial photograph showing a large, calm lake surrounded by dense green forests and rolling hills. A small settlement with several buildings is visible on the left side of the lake. The water is a clear, light blue-green color.

ADVANTAGES OF KITSAULT ENERGY AS A DEDICATED ENERGY CORRIDOR AND EXPORT TERMINAL

6. Sufficient land for FLNG, Land Based LNG, Port, Export Terminal, and other infrastructure.

An aerial photograph of a large, calm lake surrounded by dense green forests. A small settlement with several buildings and a road is visible on the left side of the lake. The water is a clear, light blue-green color.

ADVANTAGES OF KITSAULT ENERGY AS A DEDICATED ENERGY CORRIDOR AND EXPORT TERMINAL

7. It will save two to three years in project planning, construction of pipelines and other facilities.

An aerial photograph of a large, calm reservoir surrounded by dense green forest. A small settlement with several buildings is visible on the left side of the reservoir. The water is a clear, light blue-green color.

ADVANTAGES OF KITSAULT ENERGY AS A DEDICATED ENERGY CORRIDOR AND EXPORT TERMINAL

8. A project using Kitsault, can save as much as 5 Billion USD from the total cost of the project.



ADVANTAGES OF KITSAULT ENERGY AS A DEDICATED ENERGY CORRIDOR AND EXPORT TERMINAL

9. The pipeline can be shorter by 100 to 200 kilometers, and savings on this alone can be 1 to 3 Billion USD in cost and 1 or more years of time.

An aerial photograph of a large, calm lake surrounded by dense green forests. A small settlement with several buildings and a road is visible on the left side of the lake. The water is a clear, light blue-green color.

ADVANTAGES OF KITSAULT ENERGY AS A DEDICATED ENERGY CORRIDOR AND EXPORT TERMINAL

10. Kitsault is a privately owned Fee Simple Property, with 350 acres of land. Additionally, many thousands of acres of land are available if needed.

An aerial photograph of a large, calm lake surrounded by dense green forests. A small settlement with several buildings and a road is visible on the left side of the lake. The water is a clear, light blue-green color.

ADVANTAGES OF KITSAULT ENERGY AS A DEDICATED ENERGY CORRIDOR AND EXPORT TERMINAL

11. Kitsault is located in the Regional District and not a Municipality. Therefore, industrial and other taxes will be lower with potential savings of hundreds of millions USD or more per year in taxes alone.

An aerial photograph of a large, calm lake surrounded by dense green forests. A small settlement with several buildings and a road is visible on the left side of the lake. The water is a clear, light blue-green color.

ADVANTAGES OF KITSAULT ENERGY AS A DEDICATED ENERGY CORRIDOR AND EXPORT TERMINAL

12. Kitsault used to be a Molybdenum (used for strengthening steel) Mine, and as a result, extensive environmental assessment has been performed for the site itself as recently as 2012.

An aerial photograph of a large, calm lake surrounded by dense green forests. A small settlement with several buildings and a road is visible on the left side of the lake. The water is a clear, light blue-green color.

ADVANTAGES OF KITSAULT ENERGY AS A DEDICATED ENERGY CORRIDOR AND EXPORT TERMINAL

13. The pipeline from Northeast B.C. to Kitsault will primarily be along less populated Crown Land and some First Nation's land with little variation in elevation, and therefore causing the least environmental impact.

An aerial photograph of a large, calm lake surrounded by dense green forests. A small settlement with several buildings and a road is visible on the left side of the lake. The water is a clear, light blue-green color.

ADVANTAGES OF KITSAULT ENERGY AS A DEDICATED ENERGY CORRIDOR AND EXPORT TERMINAL

14. From Kitsault's Export Terminal, the Tankers, Barges and Ships can enter the ocean quickly without experiencing any congestion from navigation related to other traffic such as containers or grain loading and unloading as in other ports.

An aerial photograph of a large, calm lake surrounded by dense green forests. A small settlement with several buildings and a road is visible on the left side of the lake. The water is a clear, light blue-green color.

ADVANTAGES OF KITSAULT ENERGY AS A DEDICATED ENERGY CORRIDOR AND EXPORT TERMINAL

15. Asia will be able to rely for their energy needs, on supplies from the privately owned Kitsault Energy and join as an equity partner to have a long term contract with a stable and reliable supply at reasonable prices from Canada, a strong, vibrant and democratic country.

An aerial photograph of a large, calm lake surrounded by dense green forests. A small settlement with several buildings and a road is visible on the left side of the lake. The water is a clear, light blue-green color.

ADVANTAGES OF KITSAULT ENERGY AS A DEDICATED ENERGY CORRIDOR AND EXPORT TERMINAL

16. A Dedicated Energy Corridor and Export Energy Terminal at Kitsault will have a tremendous future for other expansion plans benefitting British Columbia, all of Canada and Asia.



ADVANTAGES OF KITSAULT ENERGY AS A DEDICATED ENERGY CORRIDOR AND EXPORT TERMINAL

17. Investments will be made for First Nations communities for purified drinking water, sewer systems, healthcare, education, job training, jobs, and housing. Kitsault Energy alongside Best Global Talent Agency and Best Cure Foundation are eager to participate proactively in partnership with First Nations.



WWW.KITSAULTENERGY.COM

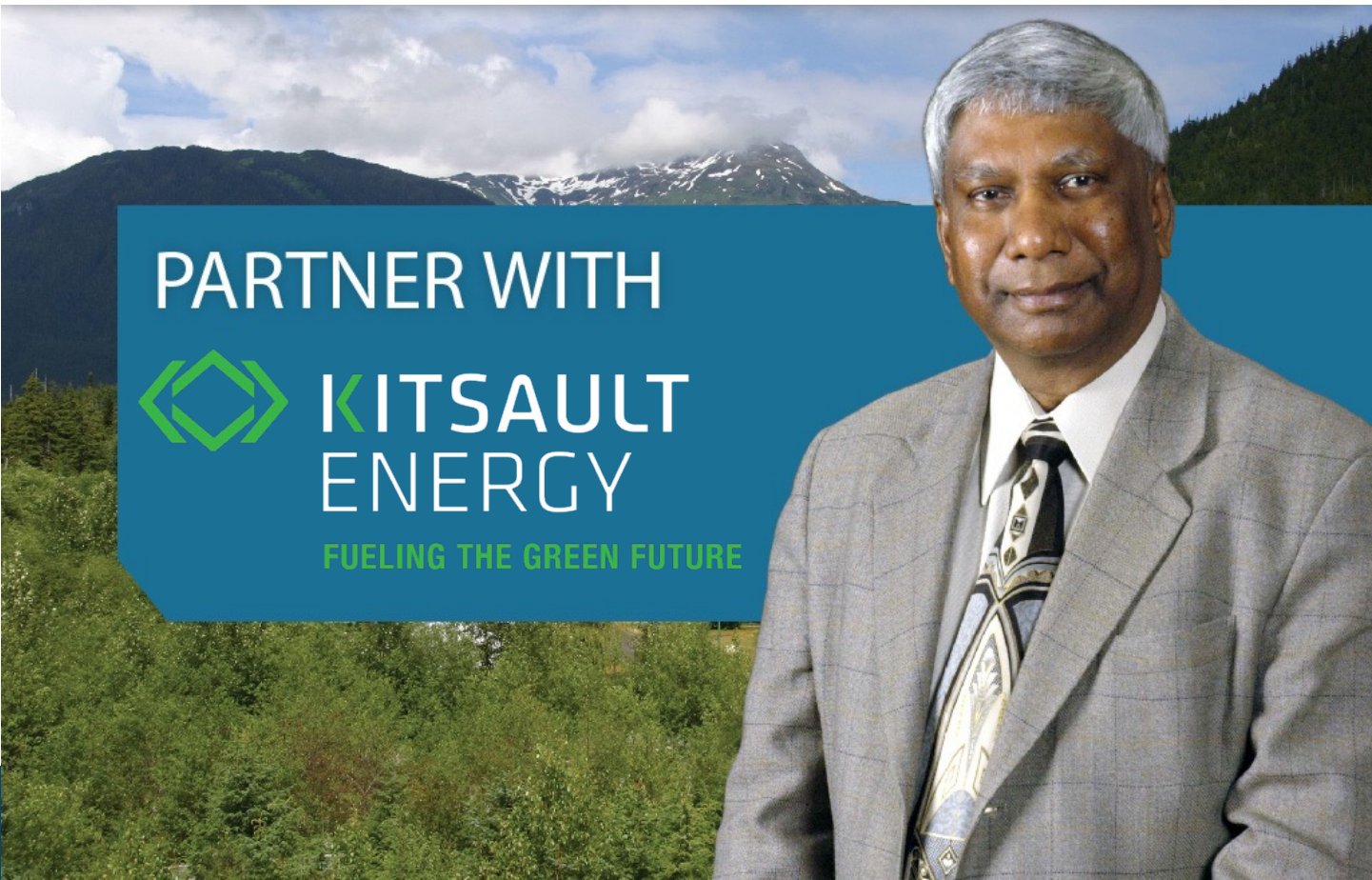

PARTNER WITH



KITSAULT
ENERGY

FUELING THE GREEN FUTURE



WWW.KITSAULTENERGY.COM

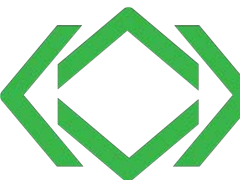

KITSAULT ENERGY

FUELING THE GREEN FUTURE

FOR MORE INFORMATION ABOUT KITSAULT ENERGY PLEASE CONTACT:

KRISH SUTHANTHIRAN
PRESIDENT
KRISH@KITSAULTENERGY.COM

kitsaultenergy.com

For more information about
Krishnan Suthanthiran,
the Best Cure Foundation or
TeamBest Global Companies and
Kitsault Energy, please visit
www.teambest.com



Thank You

